

STEREO INTEGRATED AMPLIFIER

AX-500/AX-500U

SERVICE MANUAL

For Service Manuals Contact
MAURITRON TECHNICAL SERVICES
 8 Cherry Tree Rd, Chinnor
 Oxon OX9 4QY
 Tel: 01844-351694 Fax: 01844-352554
 Email: enquiries@mauritron.co.uk

15218

IMPORTANT NOTICE

This manual has been provided for the use of authorized Yamaha Retailers and their service personnel. It has been assumed that basic service procedures inherent to the industry, and more specifically Yamaha Products, are already known and understood by the users, and have therefore not been restated.

WARNING: Failure to follow appropriate service and safety procedures when servicing this product may result in personal injury, destruction of expensive components and failure of the product to perform as specified. For these reasons, we advise all Yamaha product owners that all service required should be performed by an authorized Yamaha Retailer or the appointed service representative.

IMPORTANT: The presentation or sale of this manual to any individual or firm does not constitute authorization, certification or recognition of any applicable technical capabilities, or establish a principle-agent relationship of any form.

The data provided is believed to be accurate and applicable to the unit(s) indicated on the cover. The research, engineering, and service departments of Yamaha are continually striving to improve Yamaha products. Modifications are, therefore, inevitable and specifications are subject to change without notice or obligation to retrofit. Should any discrepancy appear to exist, please contact the distributor's Service Division.

WARNING: Static discharges can destroy expensive components. Discharge any static electricity your body may have accumulated by grounding yourself to the ground buss in the unit (heavy gauge black wires connect to this buss).

IMPORTANT: Turn the unit OFF during disassembly and parts replacement. Recheck all work before you apply power to the unit.

CONTENTS

TO SERVICE PERSONNEL	1	DISASSEMBLY PROCEDURES	5
FRONT PANELS	1	ADJUSTMENTS	5
REAR PANELS	2	PRINTED CIRCUIT BOARD	6 ~ 8
SPECIFICATIONS	3	WIRING	9
INTERNAL VIEW	3	SCHEMATIC DIAGRAM	10
BLOCK DIAGRAM	4	PARTS LIST	11 ~ 17

100081

YAMAHA
 YAMAHA CORPORATION
 P.O. Box 1, Hamamatsu, Japan

TO SERVICE PERSONNEL

1. Critical Components Information.
Components having special characteristics are marked Δ and must be replaced with parts having specifications equal to those originally installed.
2. Leakage Current Measurement (For 120V Model Only).
When service has been completed, it is imperative that you verify that all exposed conductive surfaces are properly insulated from supply circuits.
 - Meter impedance should be equivalent to 1500 ohm shunted by $0.15\mu\text{F}$.
 - Leakage current must not exceed 0.5mA.
 - Be sure to test for leakage with the AC plug in both polarities.

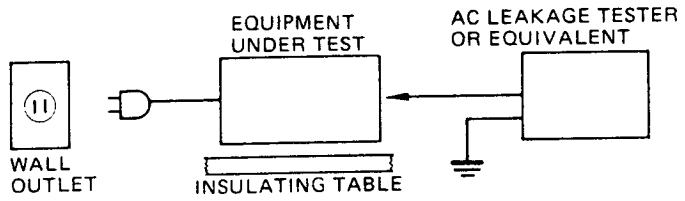

For Service Manuals Contact
MAURITRON TECHNICAL SERVICES
 8 Cherry Tree Rd, Chinnor
 Oxon OX9 4QY
 Tel: 01844-351694 Fax: 01844-352554
 Email: enquiries@mauritron.co.uk

FRONT PANELS

U.S.A. & Canadian models

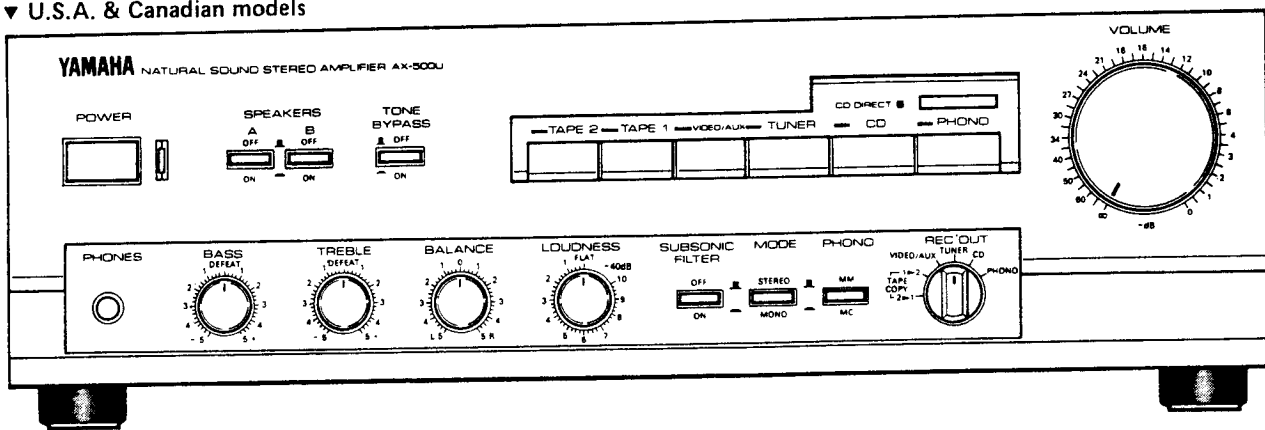

British model

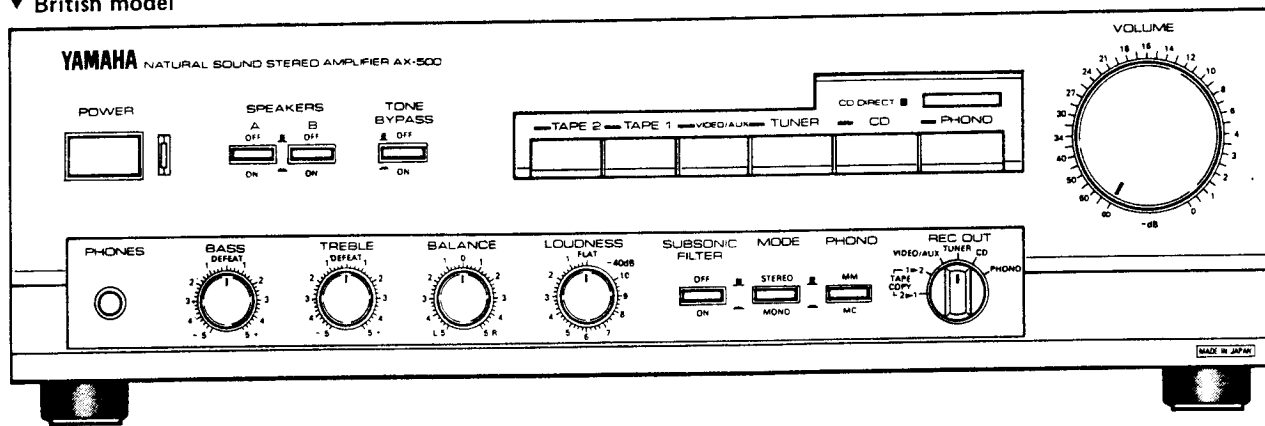

European, Australian & Other models

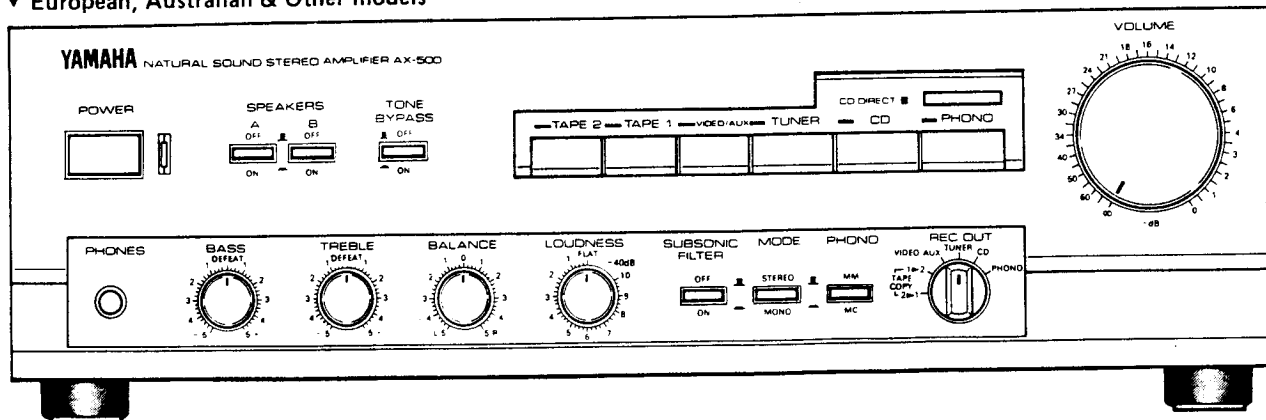

REAR PANELS

▼ U.S.A. & Canadian models

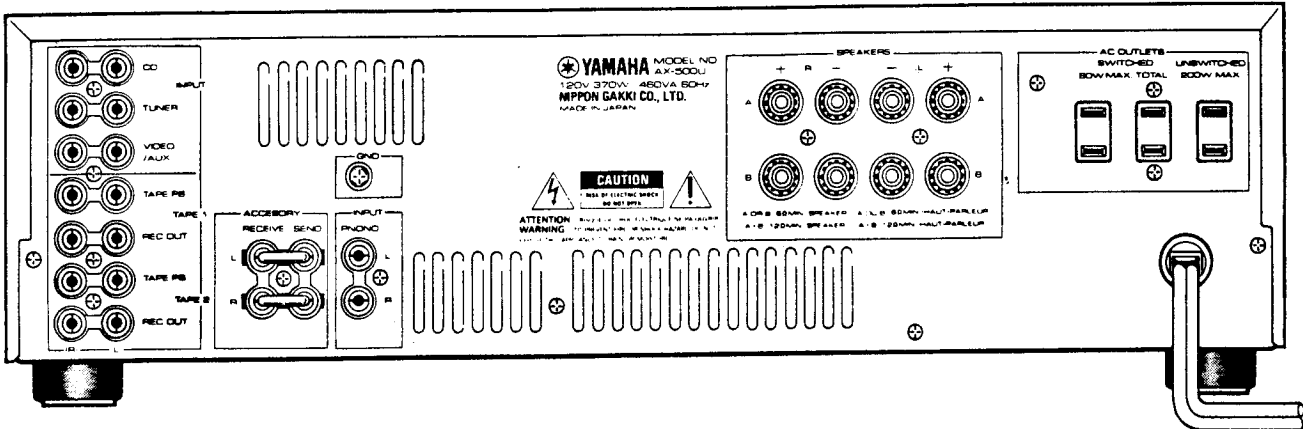

▼ Australian & British models

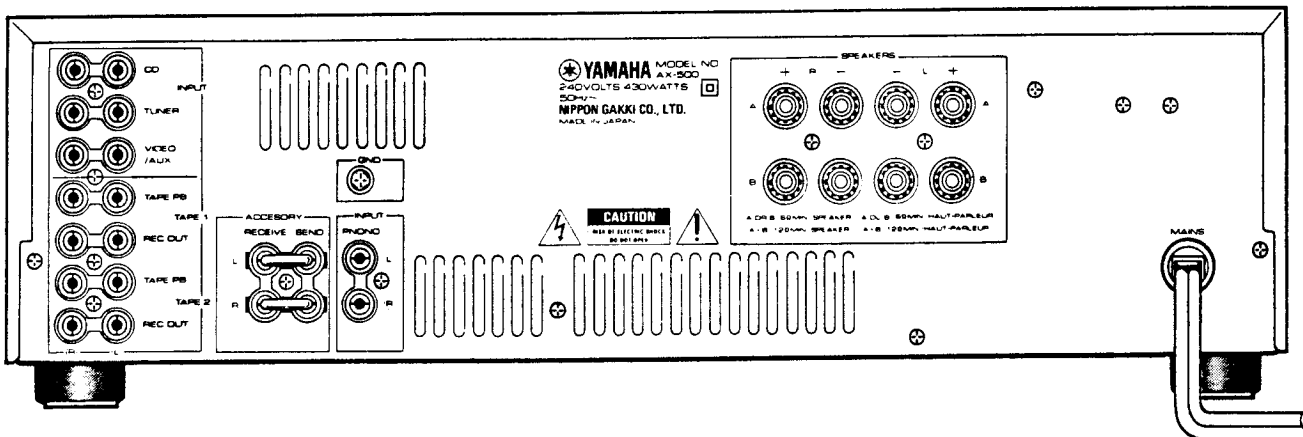

▼ European model

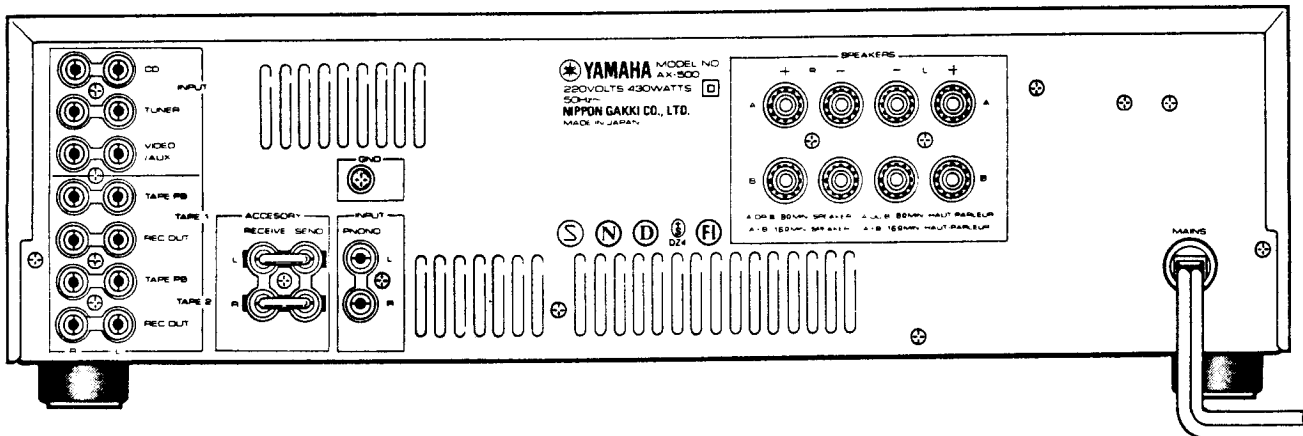

▼ Other model

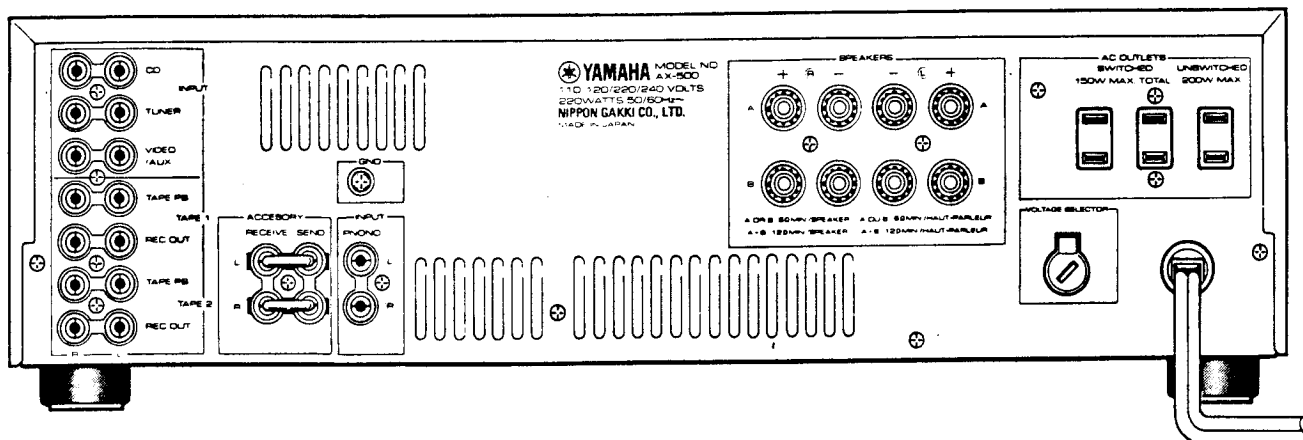

SPECIFICATIONS

Minimum RMS Output Power Per Channel	
20Hz ~ 20kHz, 0.01% THD, 8Ω	85W
20Hz ~ 20kHz, 0.015% THD, 6Ω	100W (U)(C)(R)
Dynamic Power Per Channel (by IHF Dynamic Headroom measuring method)	
8Ω	140W
6Ω	170W
4Ω	200W
2Ω	230W
DIN Standard Output Power Per Channel	
1kHz, 1% THD, 4Ω	120W (G)
Dynamic Headroom	
8Ω	2.17dB (R)(U)(C)
6Ω	2.17dB (R)(U)(C)
IEC Power	
1kHz, 1% THD, 8Ω	93W (G)
1kHz, 1% THD, 4Ω	120W (G)
Power Band Width	
0.03% THD, 42.5W, 8Ω	10Hz ~ 50kHz
Damping Factor	
1kHz, 8Ω	50
Input Sensitivity/Impedance	
Phono MC	160μV/220Ω
MM	2.5mV/47kΩ
CD etc.	150mV/47kΩ
Input Sensitivity (New IHF)	
Phono MC	19μV
MM	0.27mV
CD etc.	15.5mV
Maximum-Input Signal (1kHz)	
Phono MC	10mV
MM	150mV
Output Level/Impedance	
Rec Out	150mV/470Ω
Headphone Jack Rated Output/Impedance	
0.01% THD, RL = 8Ω	0.75V/270Ω
Frequency Response	
20Hz ~ 20kHz, CD etc.	±0.5dB
RIAA Equalization Deviation	
Phono MC	±0.5dB
MM	±0.3dB
Total Harmonic Distortion (20Hz ~ 20kHz)	
Phono MC to Rec Out (3V)	0.007%
MM to Rec Out (3V)	0.003%
Intermodulation Distortion	
CD etc. Rated Output/8Ω	0.01%

Signal to Noise Ratio (IHF-A-Network)	
Phono MC (500μV Input Shorted)	73dB
MM (5mV Input Shorted)	90dB
CD etc. (Shorted)	100dB
Signal to Noise Ratio (New IHF)	
Phono MC	72dB
MM	76dB
CD etc.	80dB
Residual Noise (IHF-A-Network)	
	140μV
Channel Separation (Vol -30dB)	
Phono MC/MM input shorted 1kHz	50dB
CD etc. input 5.1kΩ terminated 1kHz	50dB
Tone Control Characteristics	
BASS boost/cut	±10dB (at 20Hz)
turnover frequency	350Hz
TREBLE boost/cut	±10dB (at 20kHz)
turnover frequency	3.5kHz
Filter Characteristics	
Subsonic	15Hz, -12dB/oct
Continuous Loudness Control (Level related equalization)	
Attenuation	-40dB (1kHz)
Gain Tracking Error (0dB ~ -60dB)	
	2dB
Power Supply	
U.S.A. & Canadian models	AC120V, 60Hz
European model	AC220V, 50Hz
Australian & British models	AC240V, 50Hz
Other model	AC110/120/220/ 240V, 60/50Hz
Power Consumption	
U.S.A. & Canadian models	370W
Australian, European & British models	430W
Other model	220W
AC Outlet (U)(C)(R) only	
Switched x 2	80W max. (U)(C) 150W max. (R)
Unswitched x 1	200W max.
Dimension (W x H x D)	
	435 x 139 x 332 mm (17-1/8 x 5-1/2 x 13 13-1/16")
Weight	
	7.7 kg (16 lbs. 15 oz)

*Specifications are subject to change without notice.

(U) U.S.A. model (G) European model
 (C) Canadian model (B) British model
 (A) Australian model (R) Other model

INTERNAL VIEW

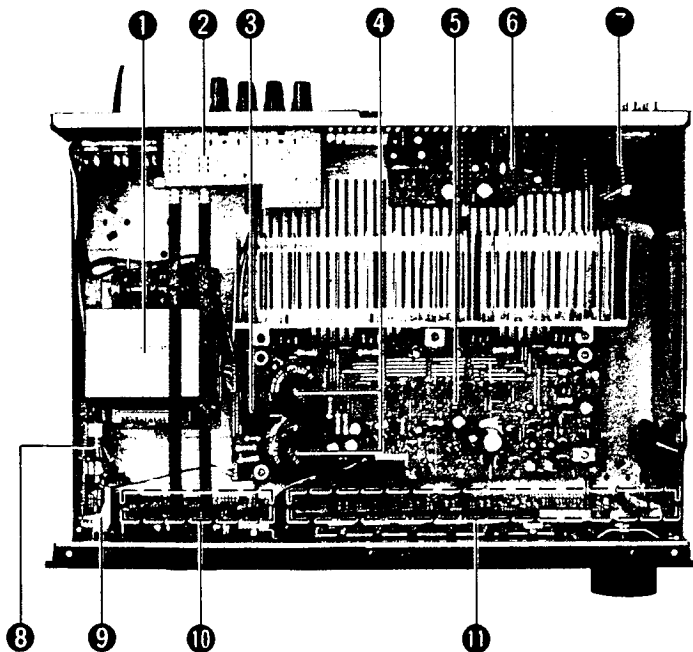

- 1 POWER TRANSFORMER
 U.S.A. model: XB792002
 Canadian model: XB795002
 European model: XB794002
 Australian & British models: XB793002
 Other model: XB791002
- 2 MAIN CIRCUIT BOARD (6)
- 3 BRIDGE DIODE: iH000870 (4D4B41)
- 4 ELECTROLYTIC CAP
 12000μF 65V: VC407000
- 5 MAIN CIRCUIT BOARD (1)
- 6 MAIN CIRCUIT BOARD (3)
- 7 MAIN CIRCUIT BOARD (4)
- 8 FUSE
 U.S.A. & Canadian models:
 KB001520 (7A 125V)
 Australian, British & European models:
 KB000760 (T3.15A 250V)
 Other model:
 KB001300 (T7.0A 250V)
- 9 POWER SWITCH
- 10 MAIN CIRCUIT BOARD (5)
- 11 MAIN CIRCUIT BOARD (2)

BLOCK DIAGRAM

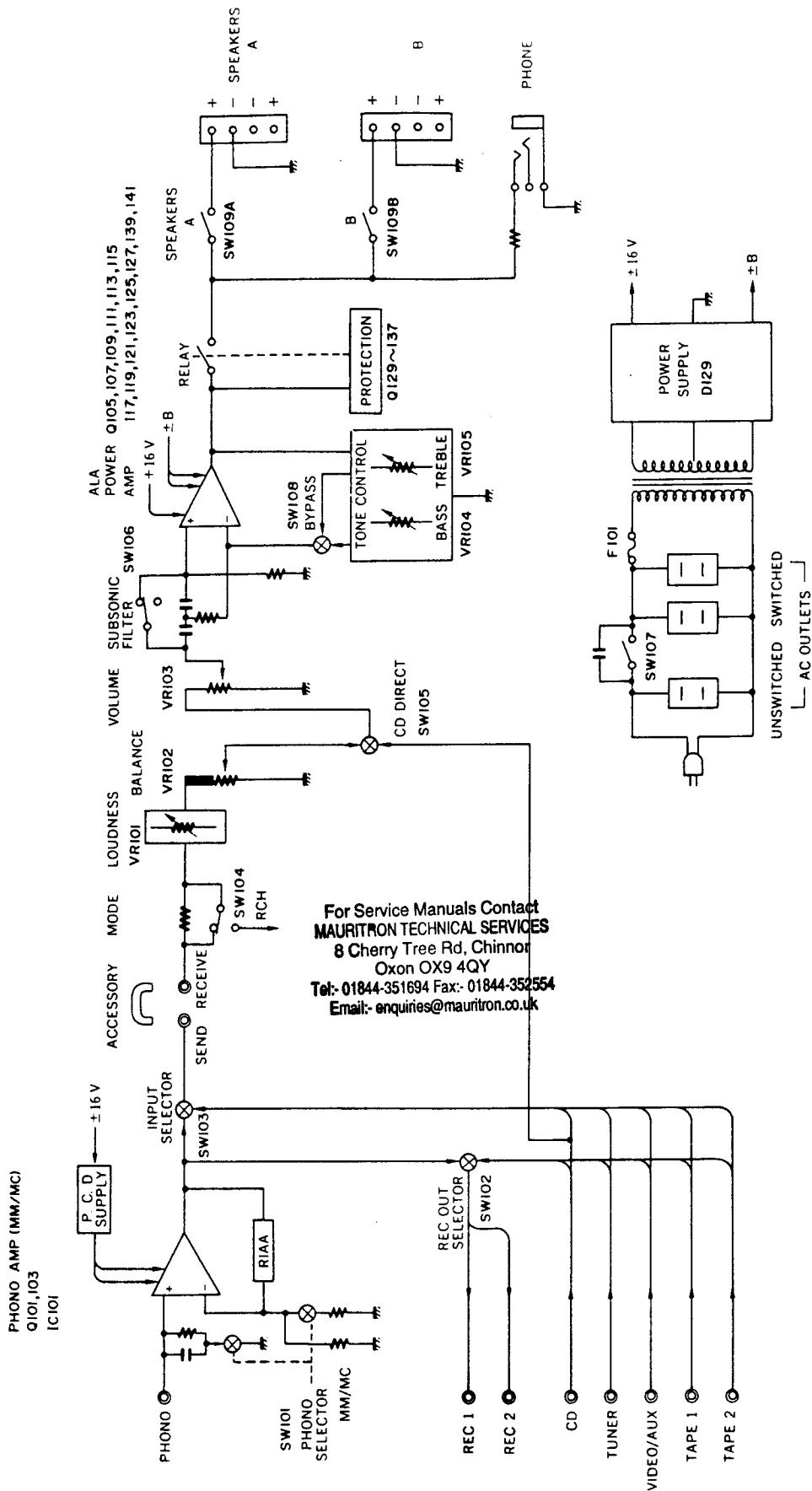

For Service Manuals Contact
MAURITRON TECHNICAL SERVICES
 8 Cherry Tree Rd, Chinnor
 Oxon OX9 4QY
 Tel: 01844-351694 Fax: 01844-352554
 Email: enquiries@mauritron.co.uk

DISASSEMBLY PROCEDURES

(Remove parts in disassembly order as numbered.)

1. **Removal of top cover**
Remove 5 screws (①).
2. **Removal of bottom cover**
Remove 7 screws (②).
3. **Removal of front panel**
Remove 6 screws (③), and pull the front panel forward.

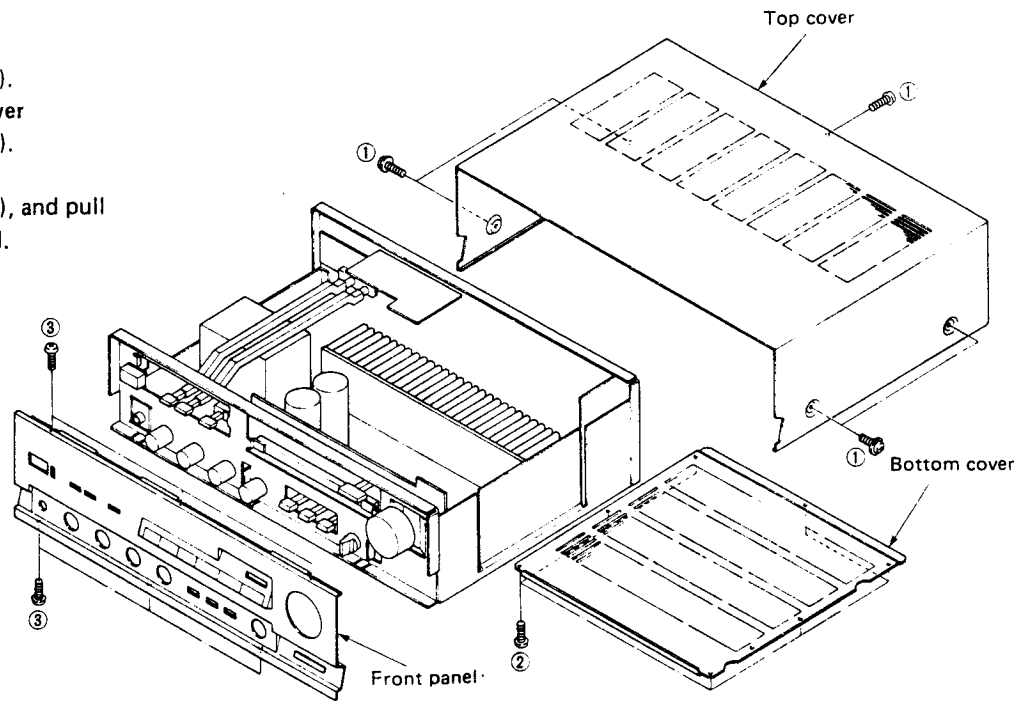

ADJUSTMENTS

● IDLING CURRENT ADJUSTMENT

When replacing the power and drive transistors, adjust idling current. Adjust idling current in no signal and non load condition.

Adjust VR107 (Lch) and VR106 (Rch) so that the voltage across the terminal of R229 and R230 come to $10\text{mV} \pm 2\text{mV DC}$.

	Test points	Adjustment points	Test points
Lch	Across the terminals of R229	VR107	$10\text{mV} \pm 2\text{mV DC}$.
Rch	Across the terminals of R230	VR106	$10\text{mV} \pm 2\text{mV DC}$.

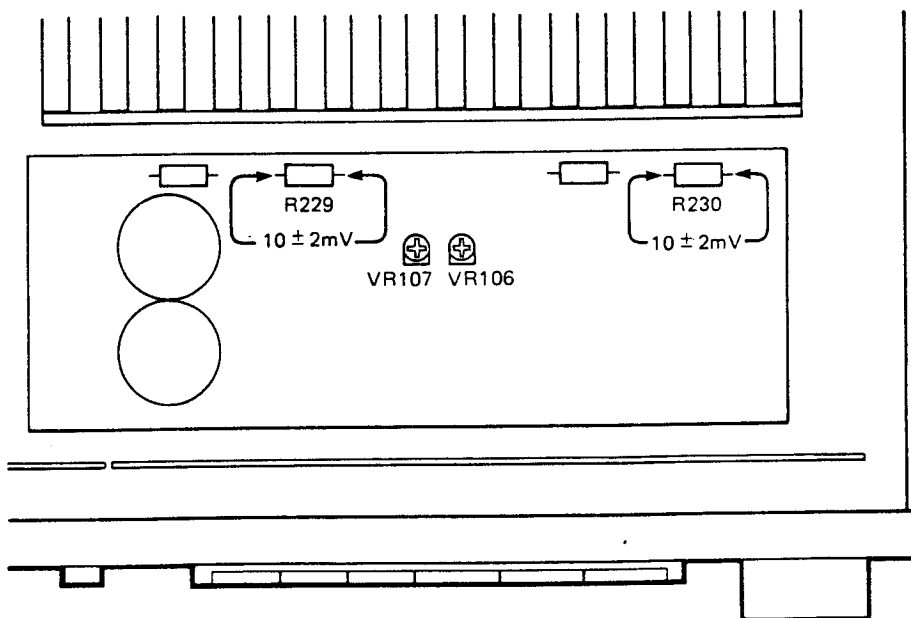

PRINTED CIRCUIT BOARD (Pattern side)

1

Main Circuit Board (1)

Note) 文字面 : Component side

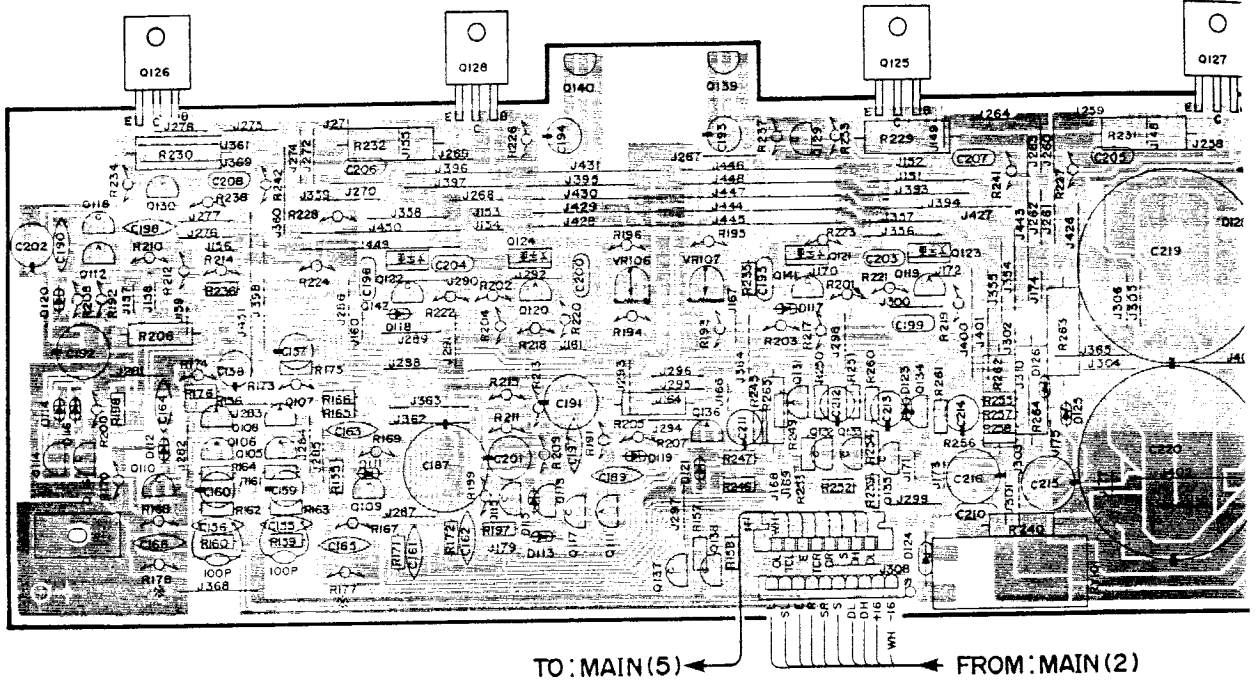

2

3

TO: MAIN (5) ← FROM: MAIN (2)

Main Circuit Board (2)

For Service Manuals Contact
 MAURITRON TECHNICAL SERVICES
 8 Cherry Tree Rd, Chinnor
 Oxon OX9 4QY
 Tel: 01844-351694 Fax: 01844-352554
 Email: enquiries@mauritron.co.uk

4

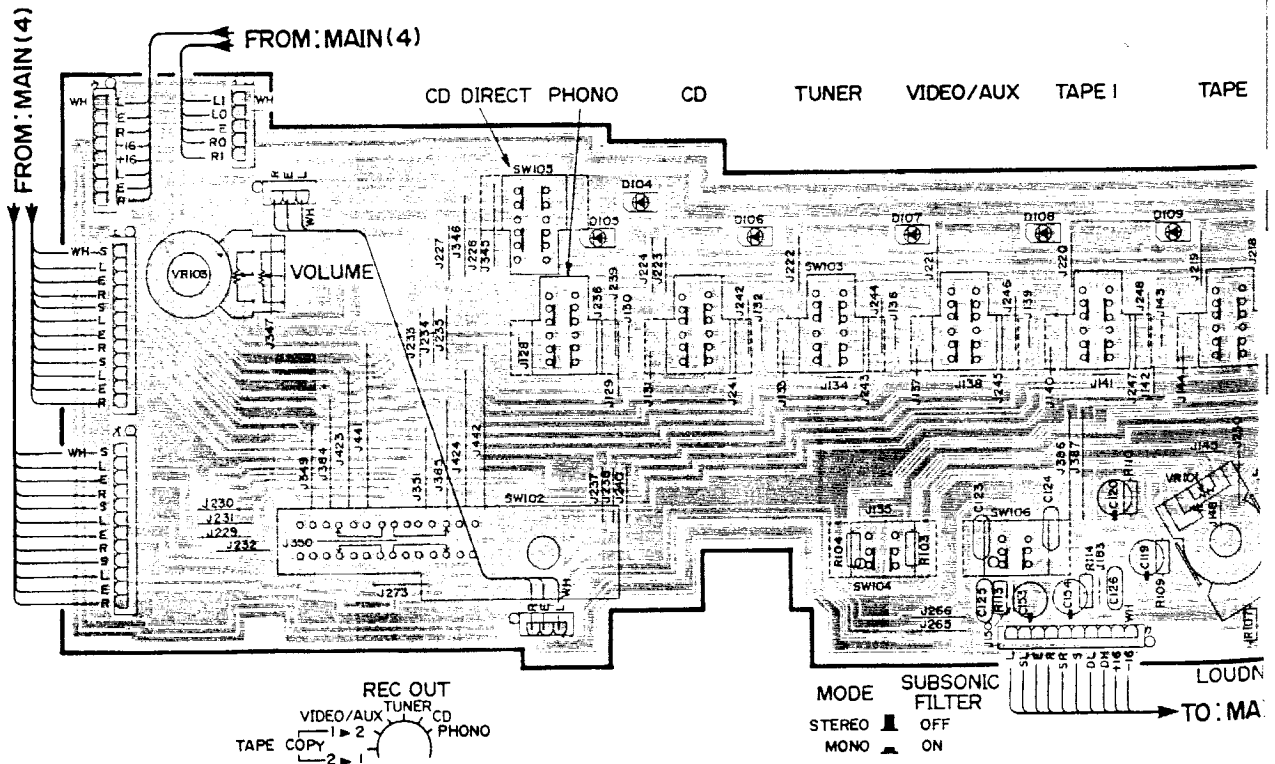

5

6

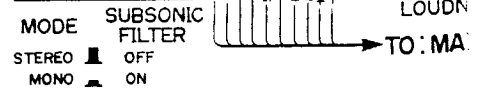
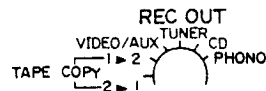

BOARD (Pattern side)

Board (1)

Note) 文字面 : Component side

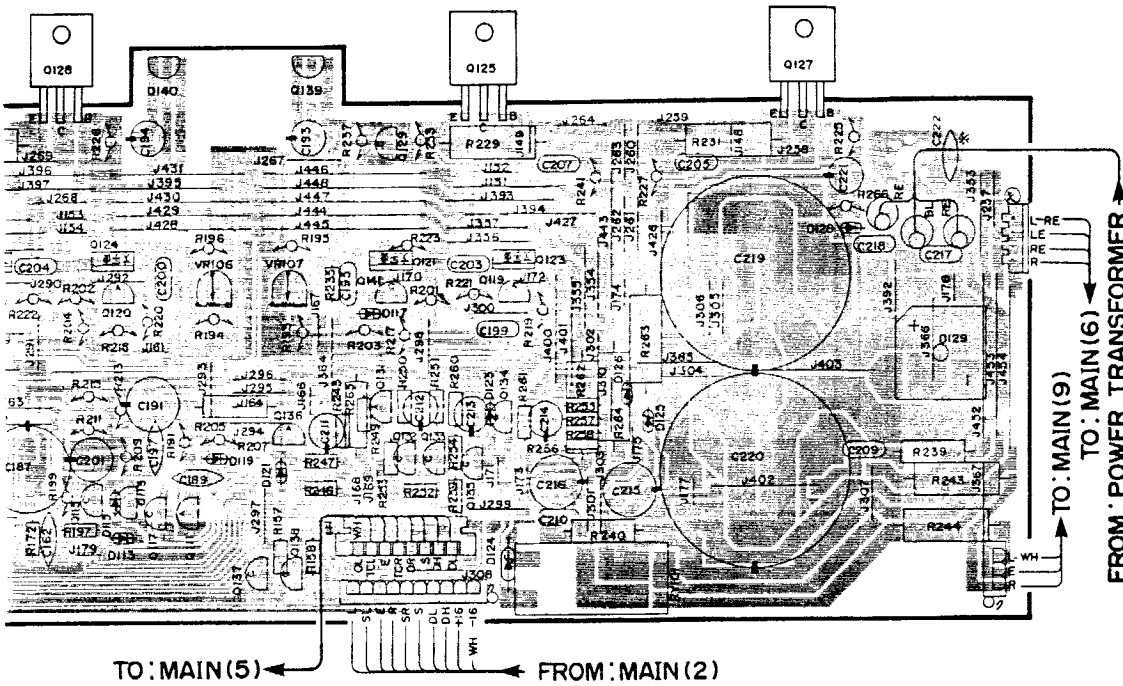

TO: MAIN (5)

FROM: MAIN (2)

TO: MAIN (9)
 TO: MAIN (6)
 FROM: POWER TRANSFORMER

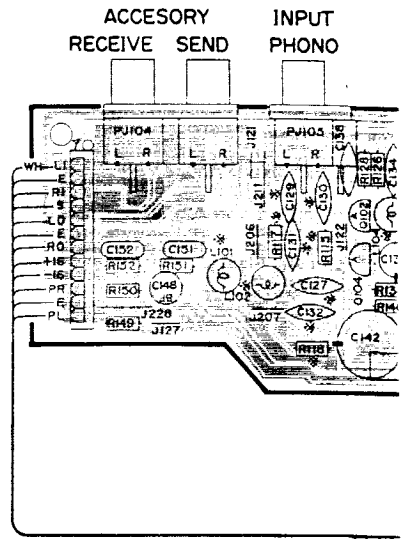

ACCESSORY
 RECEIVE SEND
 INPUT
 PHONO

Board (2)

CD DIRECT PHONO CD TUNER VIDEO/AUX TAPE 1 TAPE 2

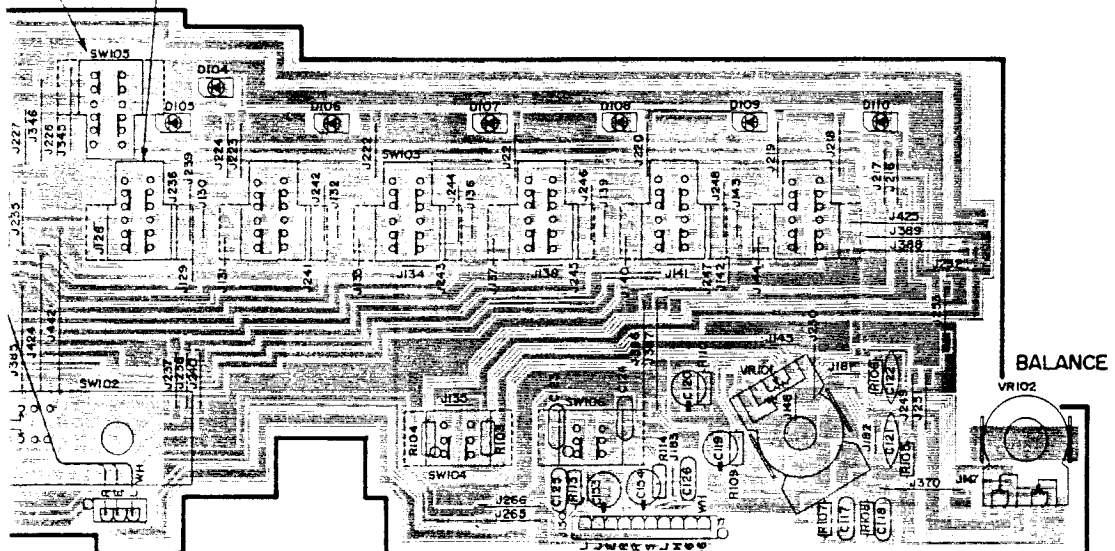

MODE SUBSONIC FILTER
 STEREO OFF
 MONO ON

LOUDNESS
 TO: MAIN (1)

Main Circuit Board (9)

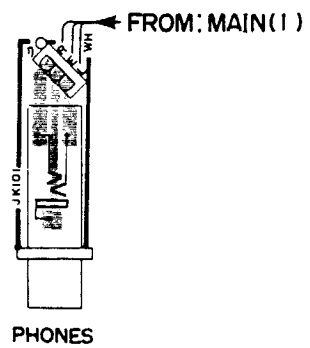

FROM: MAIN (1)

PHONES

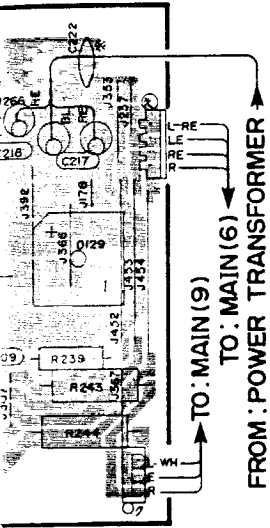
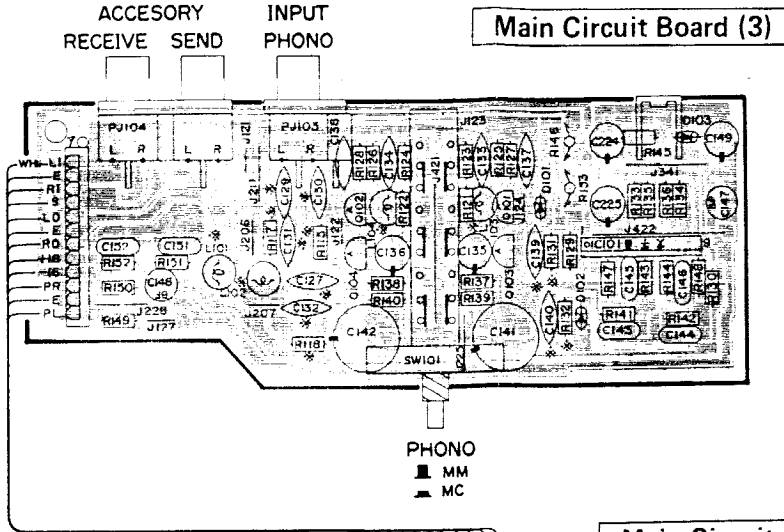

Main Circuit Board (4)

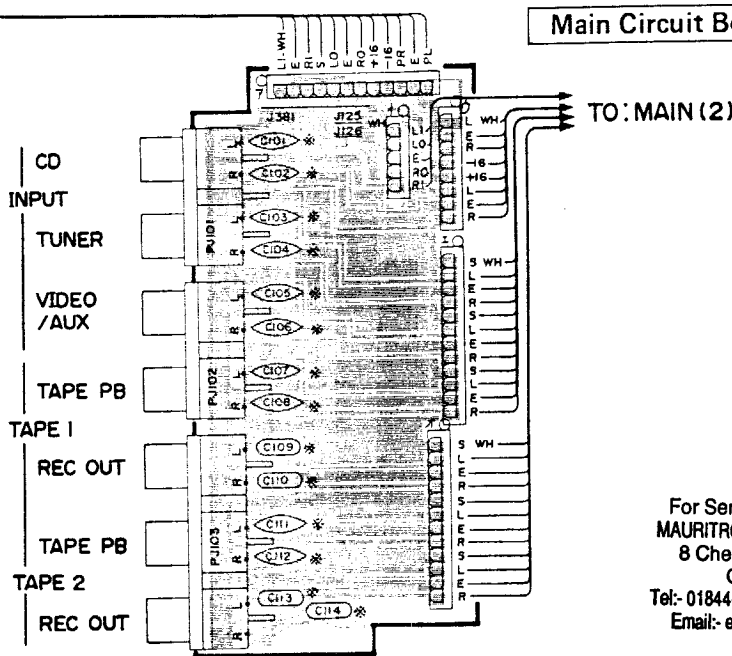

For Service Manuals Contact
MAURITRON TECHNICAL SERVICES
 8 Cherry Tree Rd, Chinnor
 Oxon OX9 4QY
 Tel:- 01844-351694 Fax:- 01844-352554
 Email:- enquiries@mauritron.co.uk

Main Circuit Board (9)

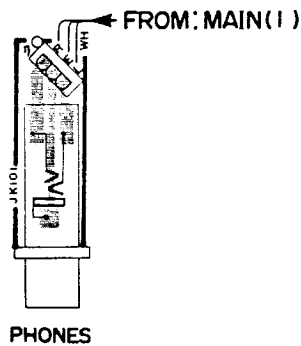
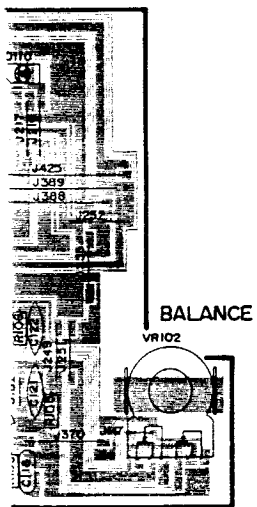

Note * marked

*	R	U	C	A, B	G
R131, 132	100				180
R177, 178	180				82
C129, 130	OPEN				150P
R117, 118	10				33
C139, 140	1500P				2700P
L101, 102	SHORT				15µH
C238	OPEN				5600P
L103, 104	OPEN				220µH
C101 ~ 108 111, 112	OPEN				470P
C222	OPEN				0.01
C227 ~ 230	OPEN				5600P
C231 ~ 236	OPEN				0.022
R269 ~ 272	OPEN				4.7
F101	T7.0A 250V	7A 125V		T3.15A 250V	
F102	T3.5A 250V	OPEN			
J331	OPEN				SHORT
C109, 110 113, 114	OPEN				470P
C231, 232	OPEN				220P
C233, 234	OPEN				270P

PRINTED CIRCUIT BOARD(Pattern side)

Main Circuit Board (8)

U,C MODELS

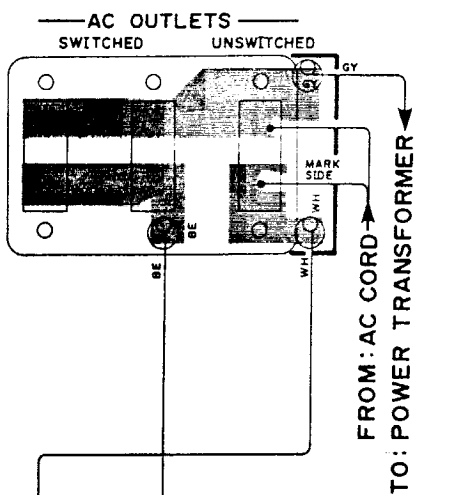

R MODEL

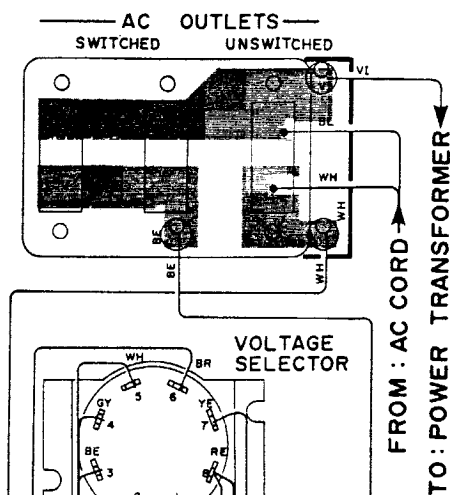

A,G



TO: POWER TRANSFORMER

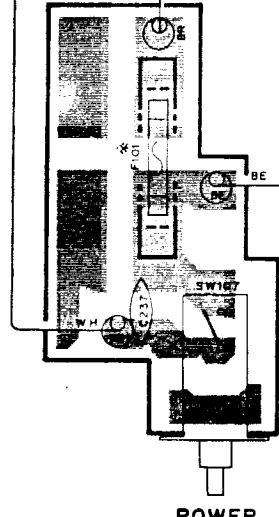

For Service Manuals Contact
MAURITRON TECHNICAL SERVICES
 8 Cherry Tree Rd, Chinnor
 Oxon OX9 4QY
 Tel:- 01844-351694 Fax:- 01844-352554
 Email:- enquiries@mauritron.co.uk

Main Circuit Board (7)

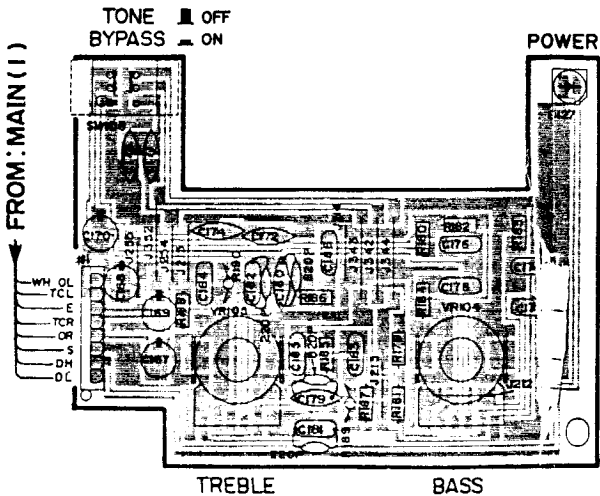
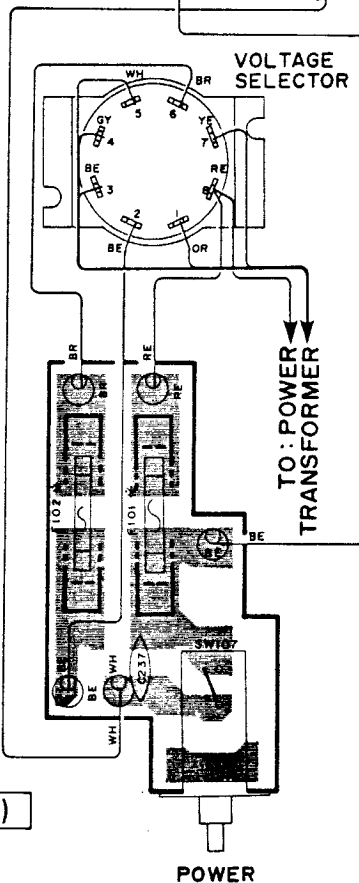

Main Circuit Board (5)

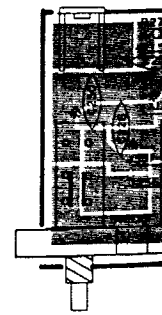

SPEAKER
 OFF
 ON

1
2
3
4
5
6
8

Pattern side)

Circuit Board (8)

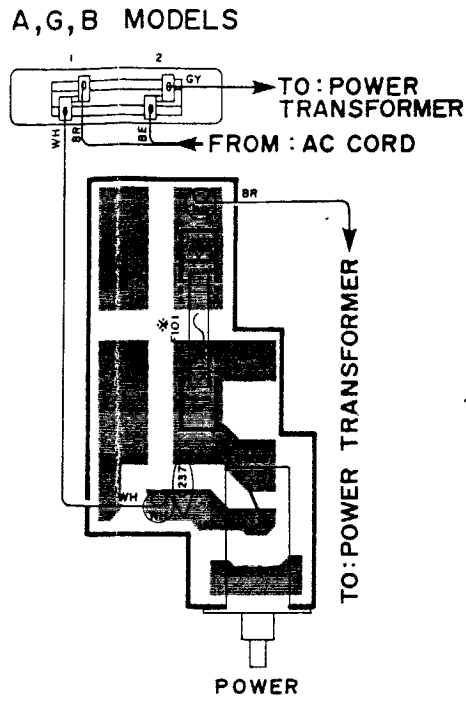
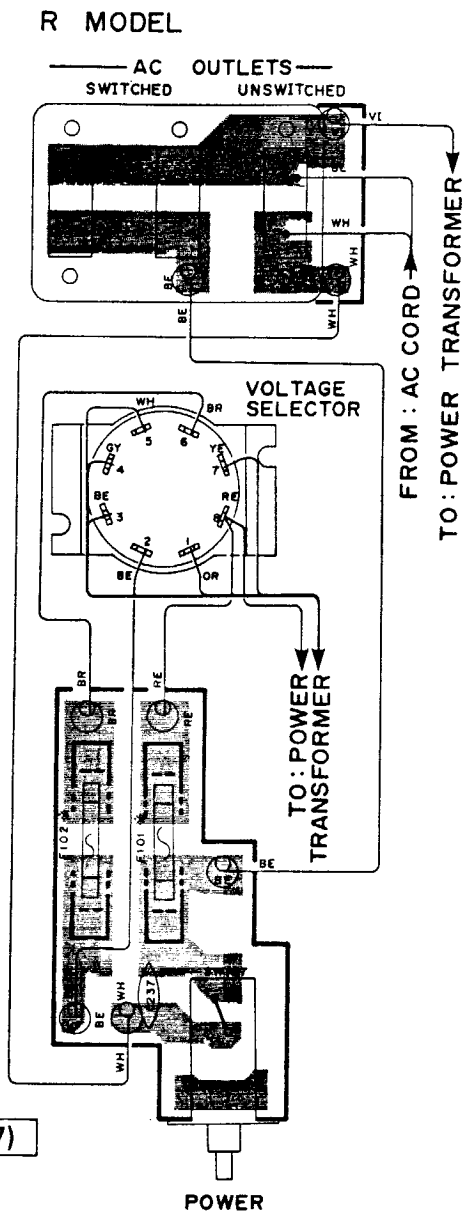

■ WIRING

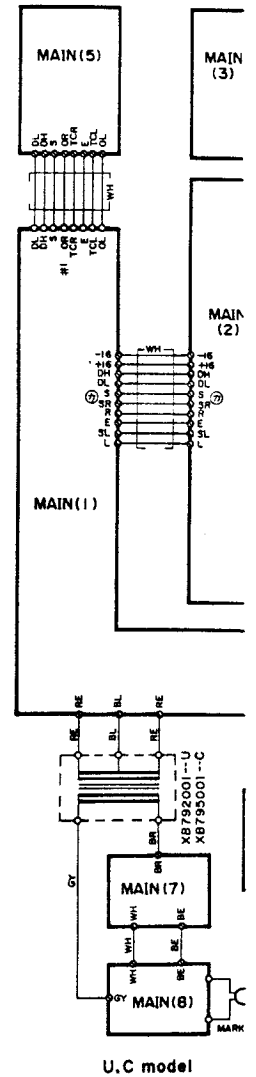

Circuit Board (7)

Main Circuit Board (6)

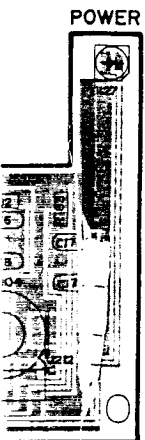

Main Circuit Board (5)

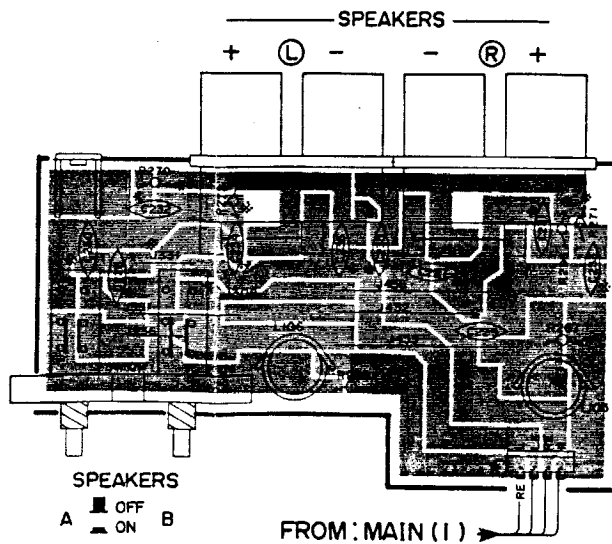

WIRING

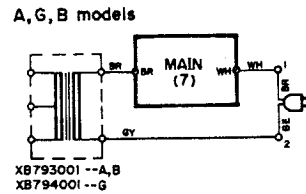
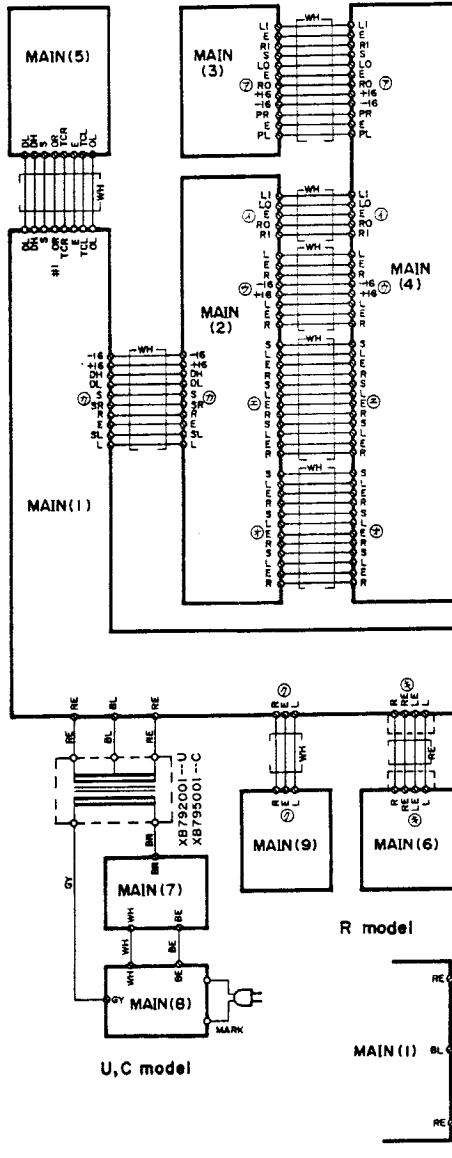
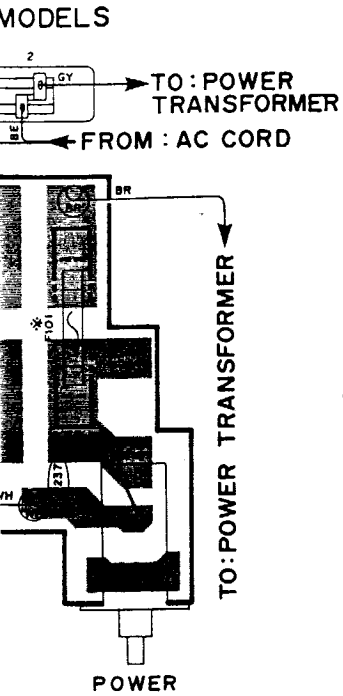

Main Circuit Board (6)

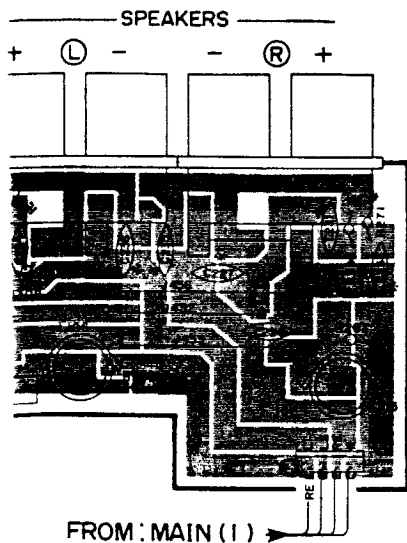

For Service Manuals Contact
MAURITRON TECHNICAL SERVICES
 8 Cherry Tree Rd, Chinnor
 Oxon OX9 4QY
 Tel: 01844-351694 Fax: 01844-352554
 Email: enquiries@mauritron.co.uk

SCHEMATIC DIAGRAM

1
2
3
4
5
6

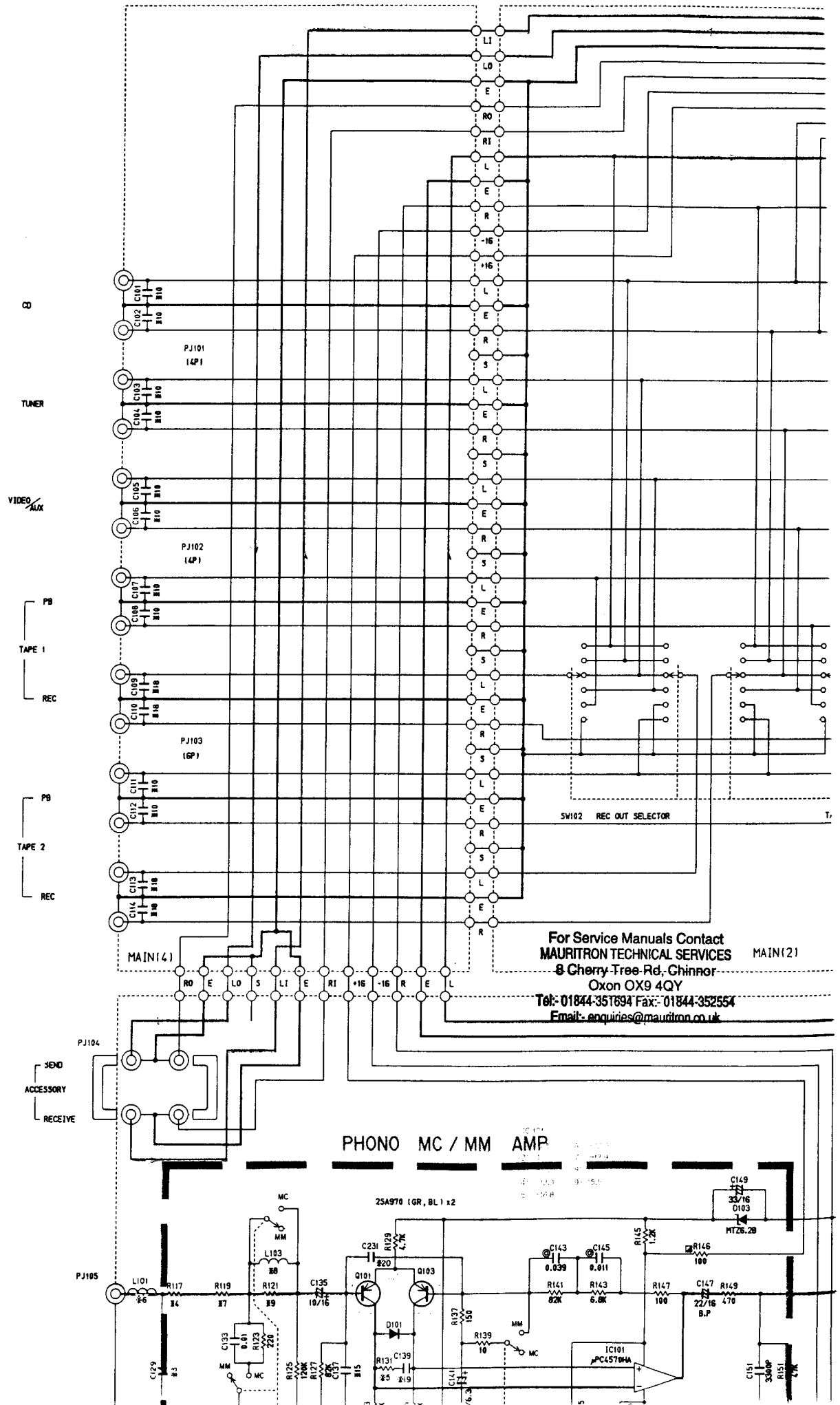

For Service Manuals Contact
MAURITRON TECHNICAL SERVICES
 8 Cherry Tree Rd, Chinnor
 Oxon OX9 4QY
 Tel: 01844-357894 Fax: 01844-352554
 Email: enquiries@mauritron.co.uk

ALA POWER AMF
with TONE CONTROL

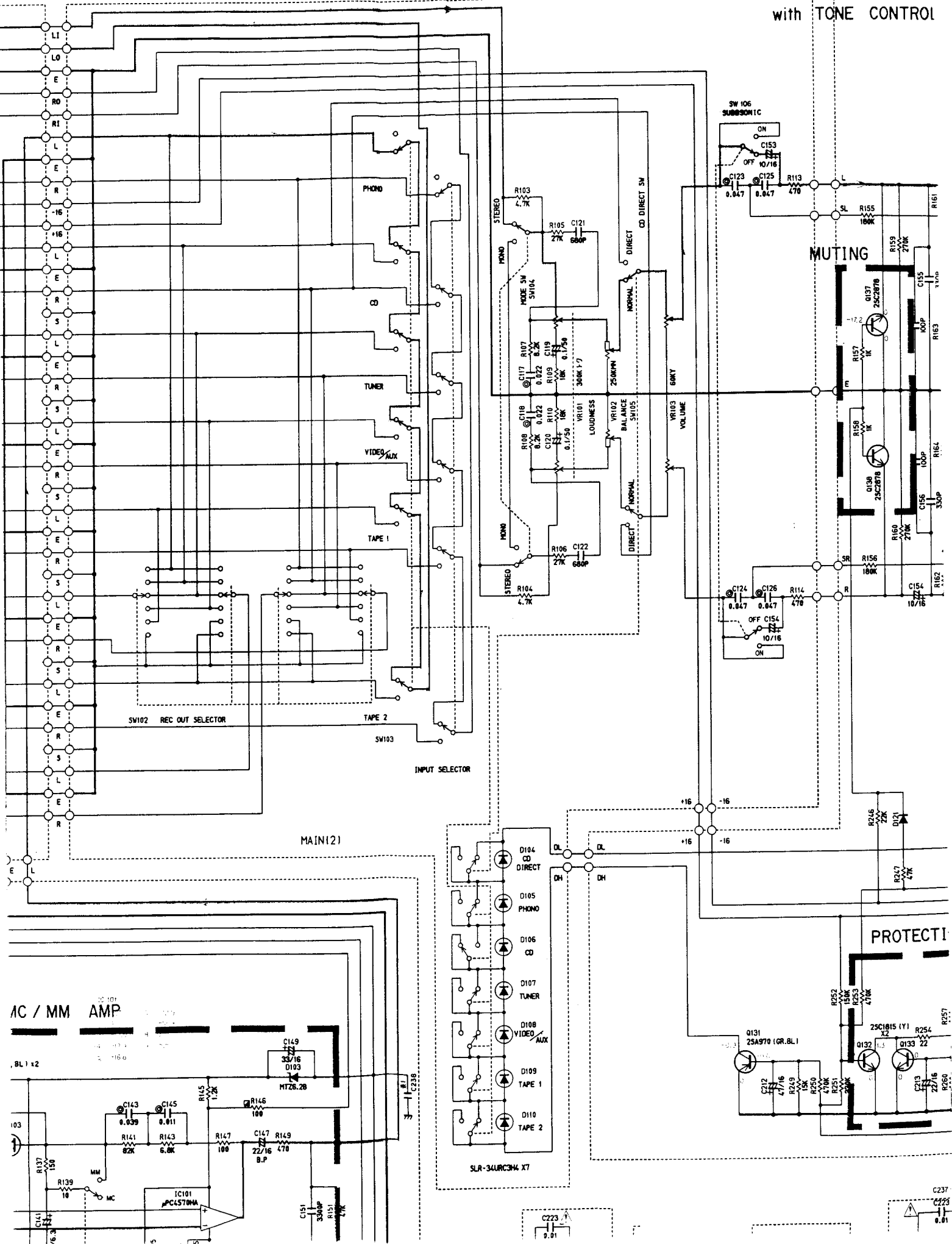

ALA POWER AMP
with TONE CONTROL

Idling Current ADJ(L)

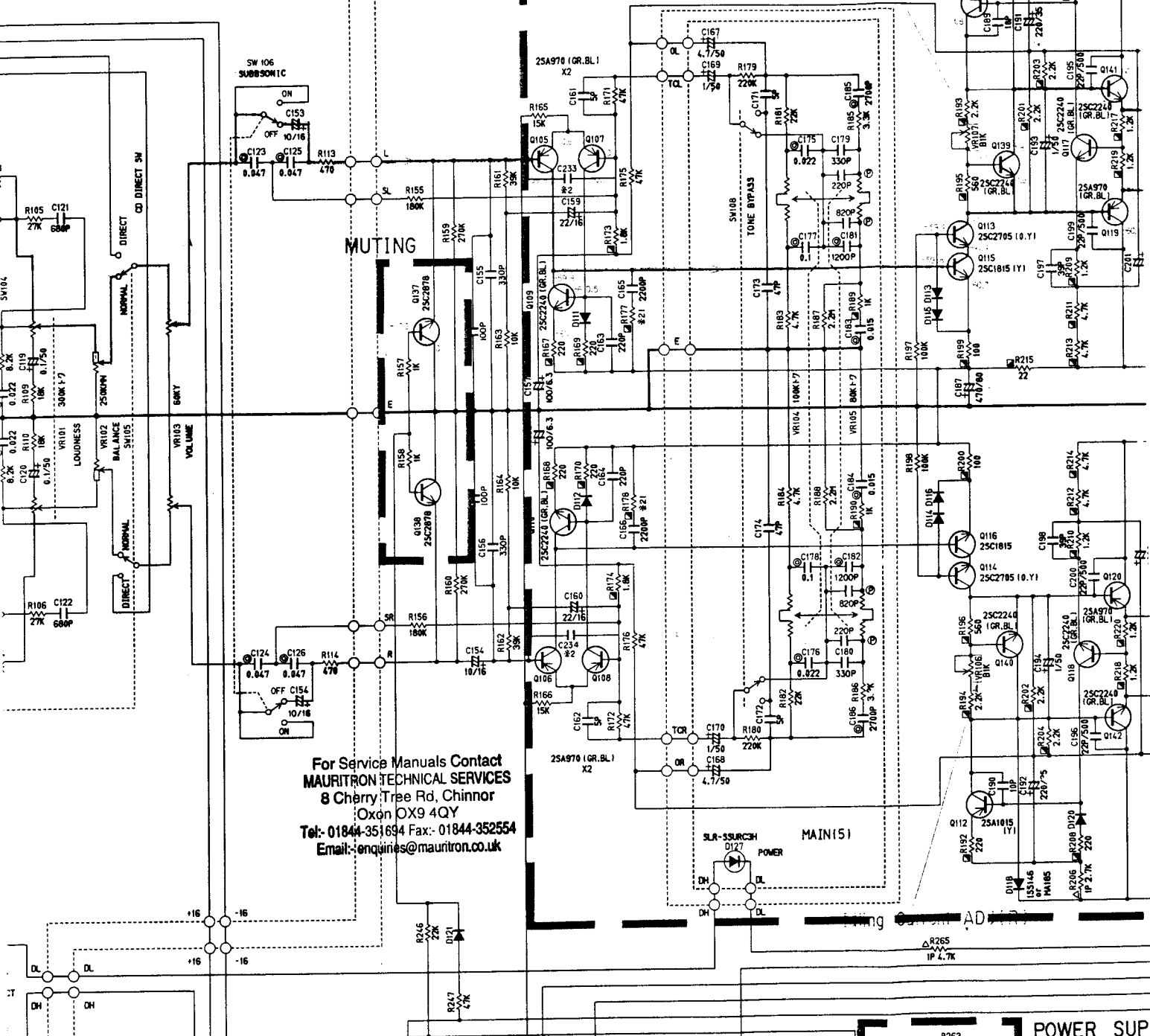

For Service Manuals Contact
MAURITRON TECHNICAL SERVICES
8 Cherry Tree Rd, Chinnor
Oxon OX9 4QY
Tel: 01844-351694 Fax: 01844-352554
Email: enquiries@mauritron.co.uk

PROTECTION

POWER SUPPLY

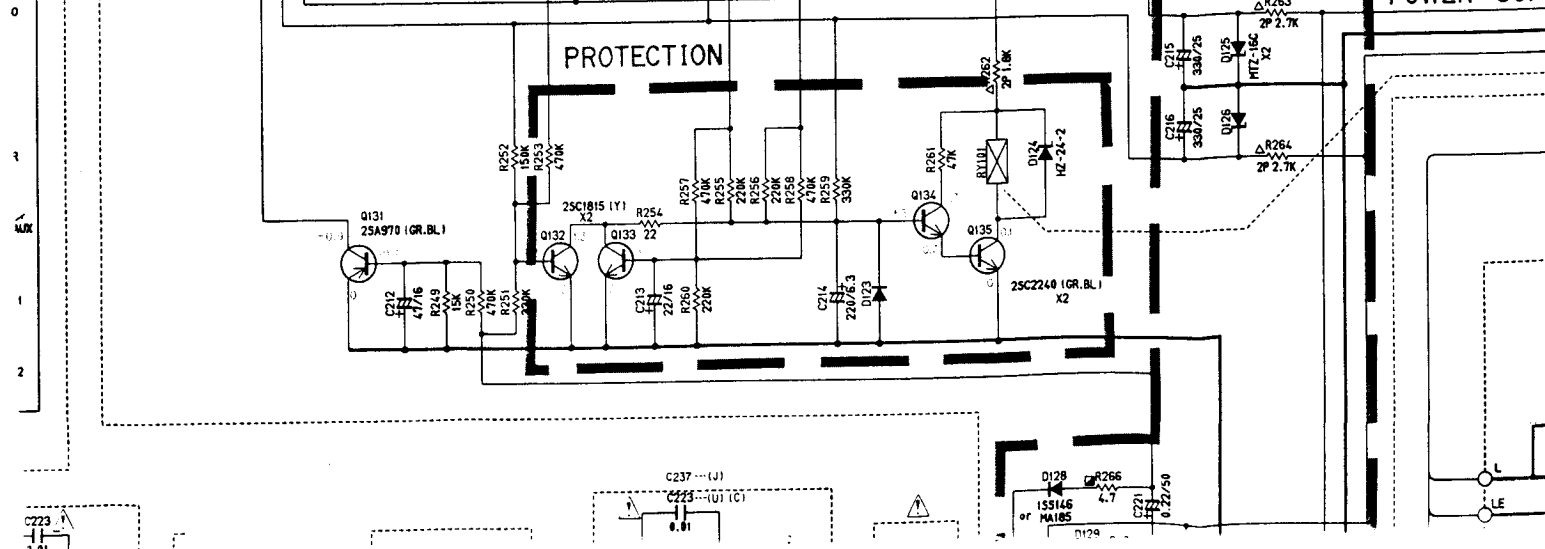

C223 (U1)
C223 (U1) C1

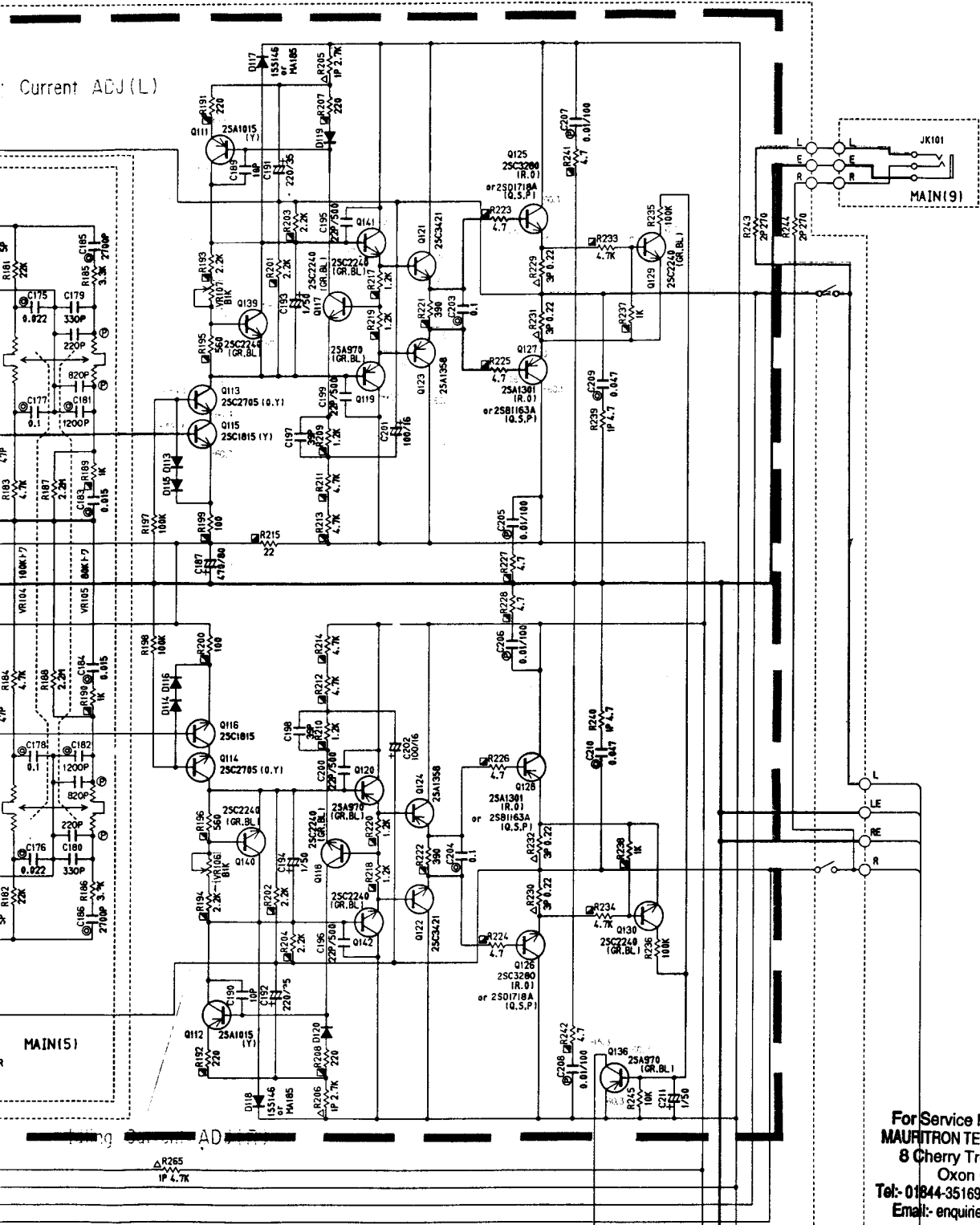

For Service Manuals Contact
MAURITRON TECHNICAL SERVICES
 8 Cherry Tree Rd, Chinnor
 Oxon OX9 4QY
 Tel:- 01844-351694 Fax:- 01844-352554
 Email:- enquiries@mairitron.co.uk

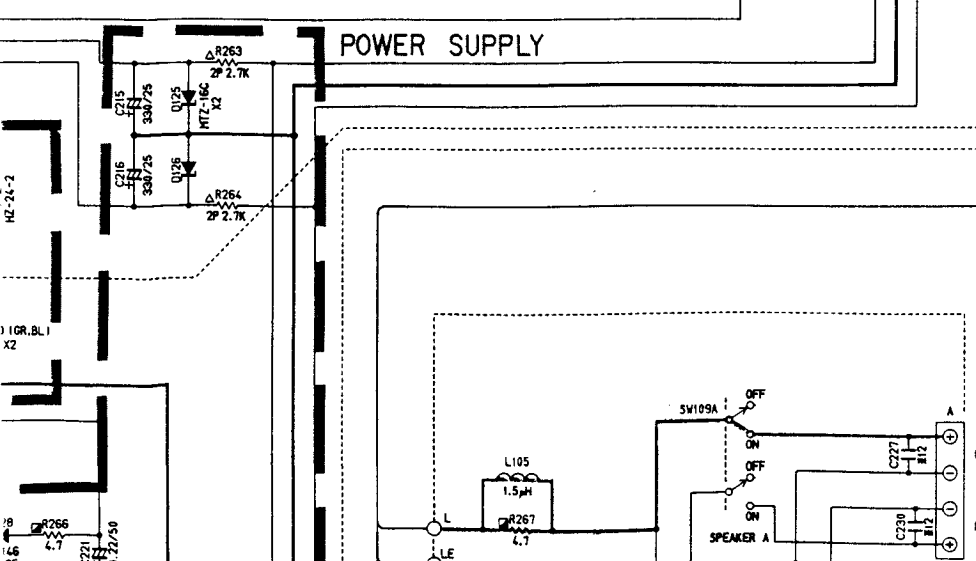

	J	U	C	R	A	B	G
#1	OPEN	←					5600P
#2	OPEN	←					270P
#3	OPEN	←					150P
#4	10	←					33
#5	100	←					180
#6	SHORT	←					15µH
#8	OPEN	←					220µH
#9	33	←					2.2K
#10	OPEN	←					470P
#11	OPEN	←					0.01
#12	OPEN	←					0.01

3

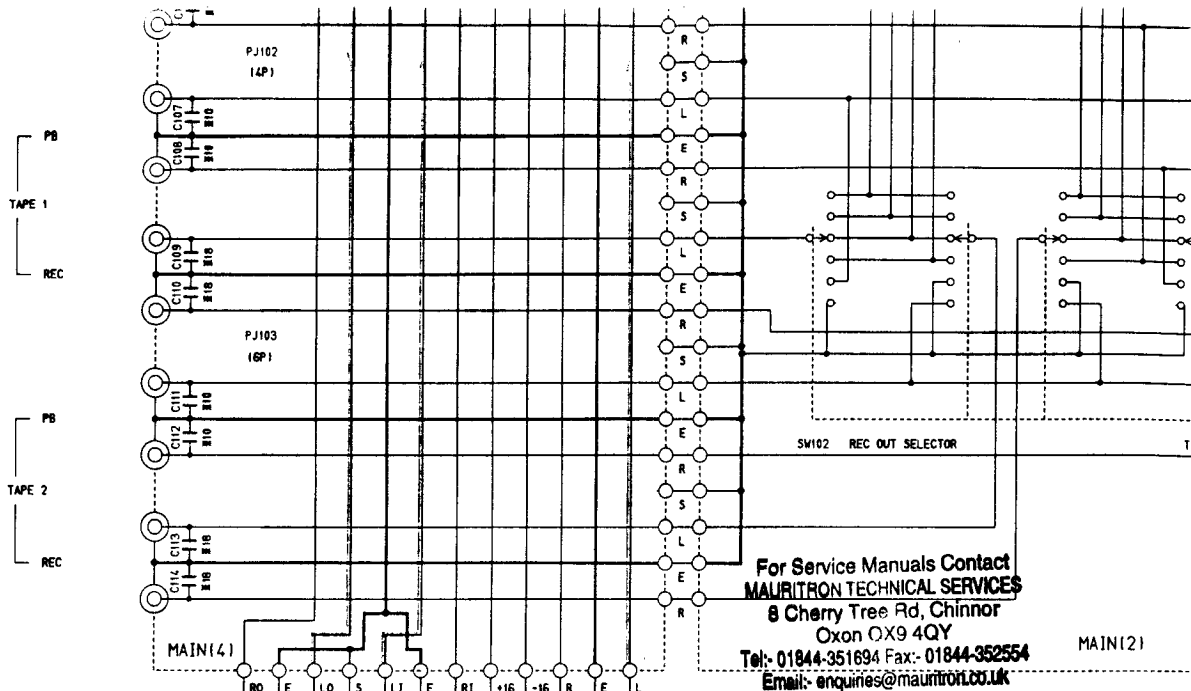

For Service Manuals Contact
MALTRON TECHNICAL SERVICES
 8 Cherry Tree Rd, Chinnor
 Oxon OX9 4QY
 Tel: 01844-351694 Fax: 01844-352554
 Email: enquiries@maltron.co.uk

4

5

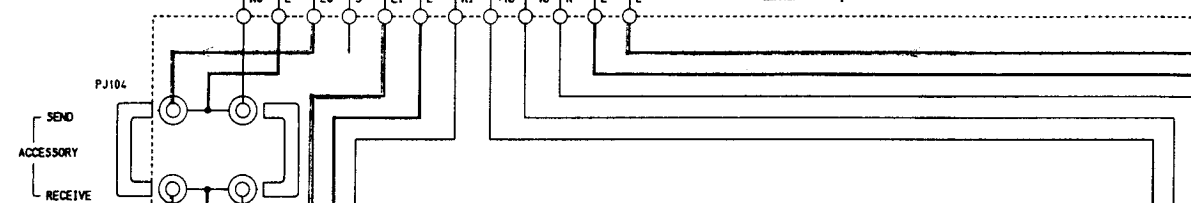

6

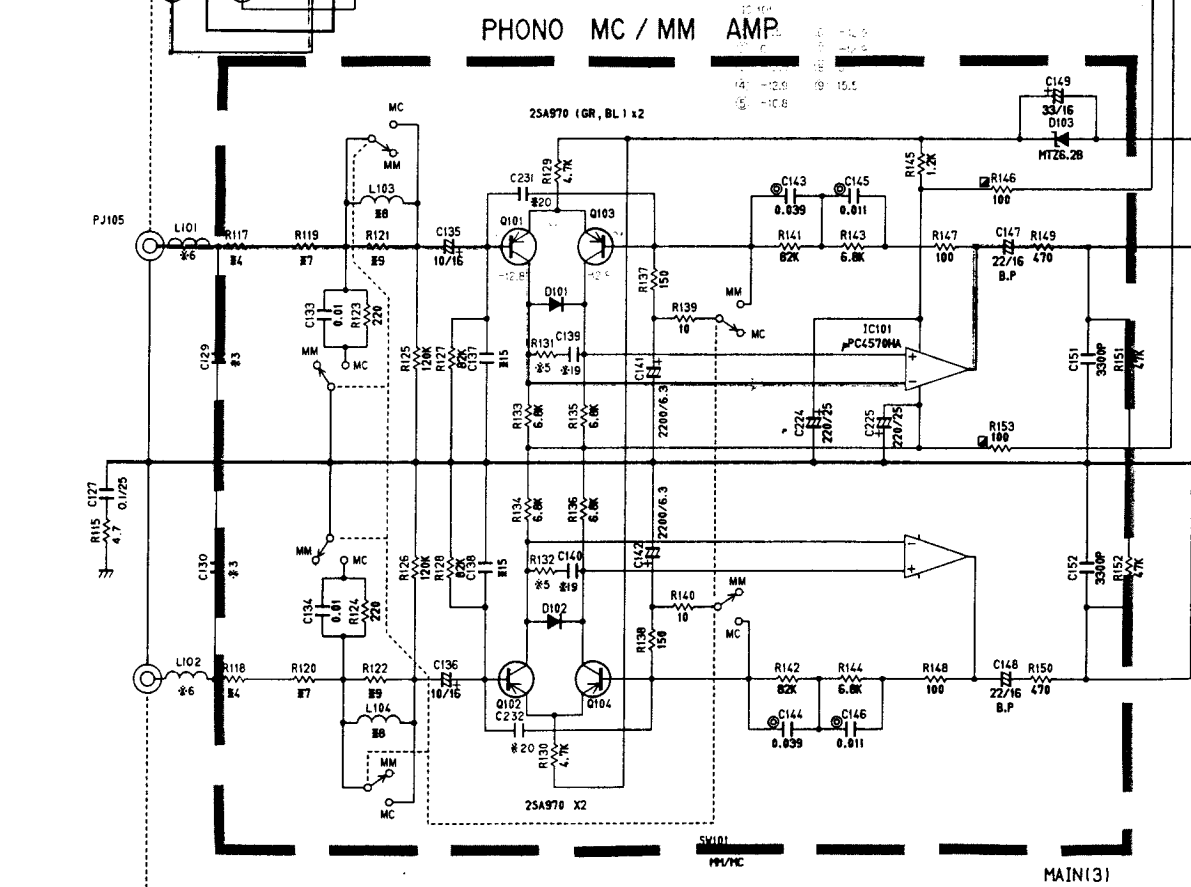

7

8

PIN CONNECTIC

2SA970 (GR, BL)
2SA1015 (Y)
2SC1815 (Y)
2SC2240 (GR, B)
2SC2878

B & C

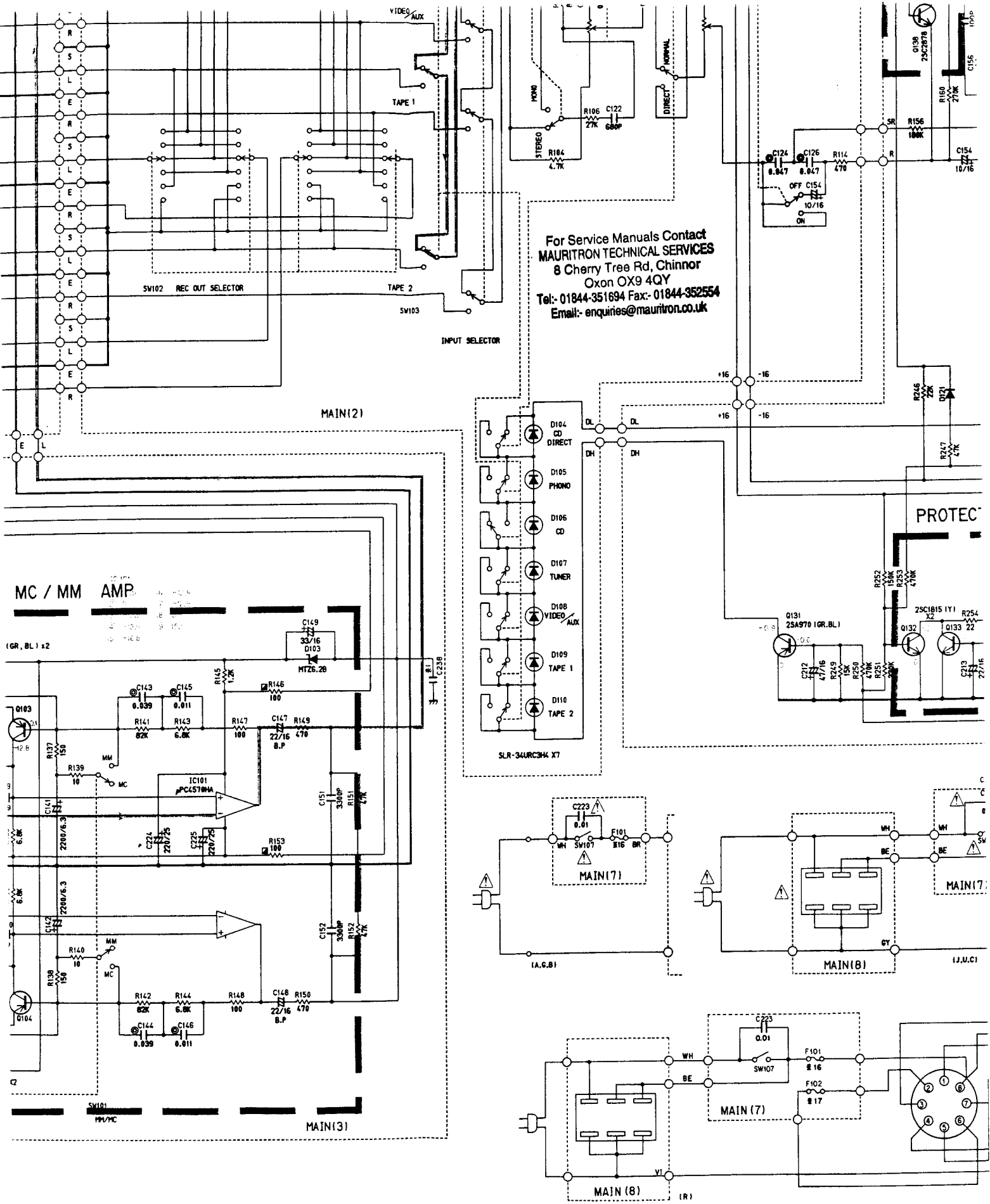

For Service Manuals Contact
MAURITRON TECHNICAL SERVICES
 8 Cherry Tree Rd, Chinnor
 Oxon OX9 4QY
 Tel: 01844-351694 Fax: 01844-352554
 Email: enquiries@mauratron.co.uk

PIN CONNECTION DIAGRAM OF TRANSISTORS, DIODES AND ICs.

<p>2SA970 (GR, BL) 2SA1015 (Y) 2SC1815 (Y) 2SC2240 (GR, BL) 2SC2878</p>	<p>2SC2705 (O, Y)</p>	<p>2SA1358 2SC3421</p>	<p>HZ24-2 MTZ16C MTZ6.2B 1SS133 1SS146</p>	<p>SLR-55URC3H SLR-34URC3H4</p>
---	-----------------------	-------------------------------------	--	--

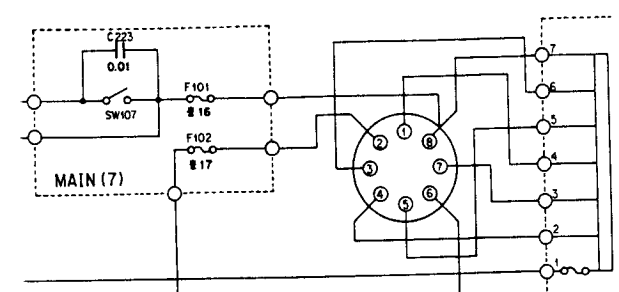
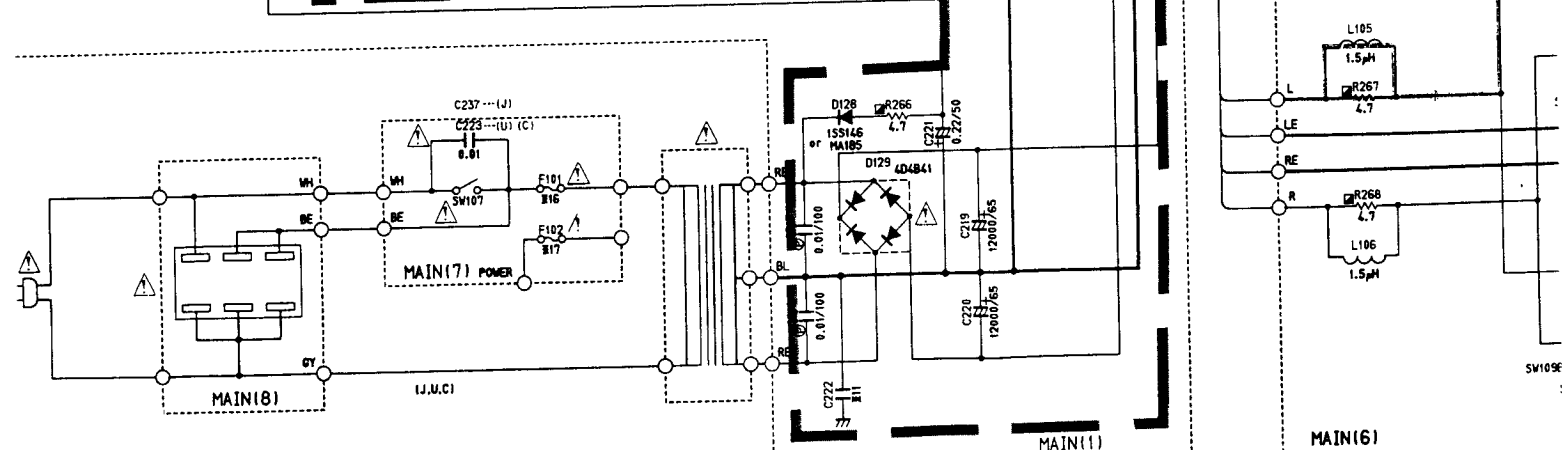
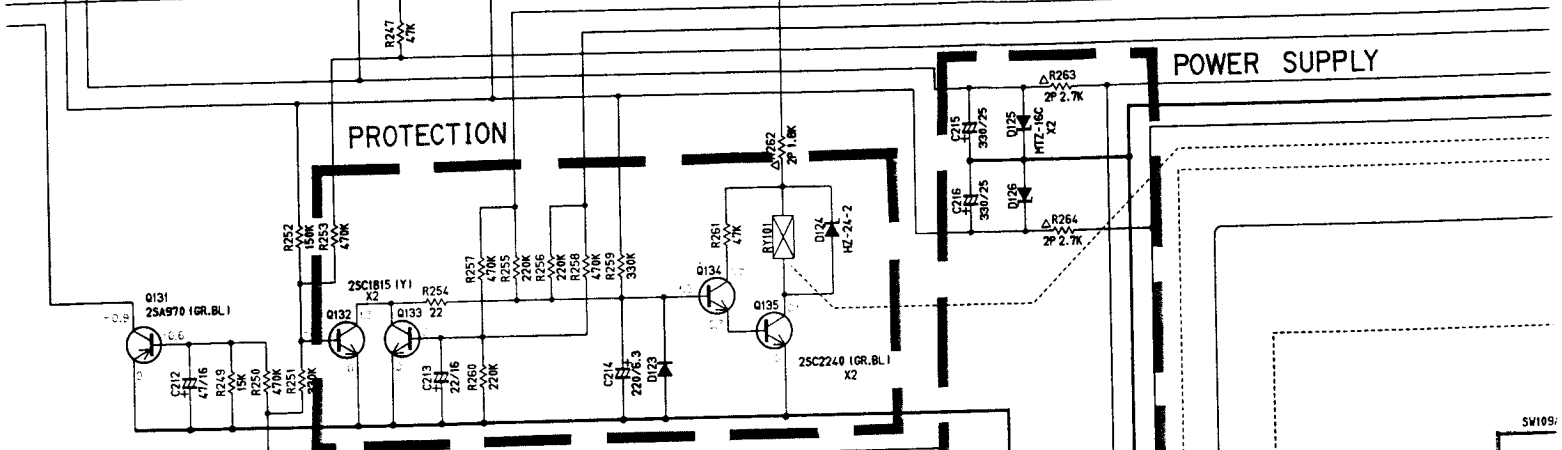
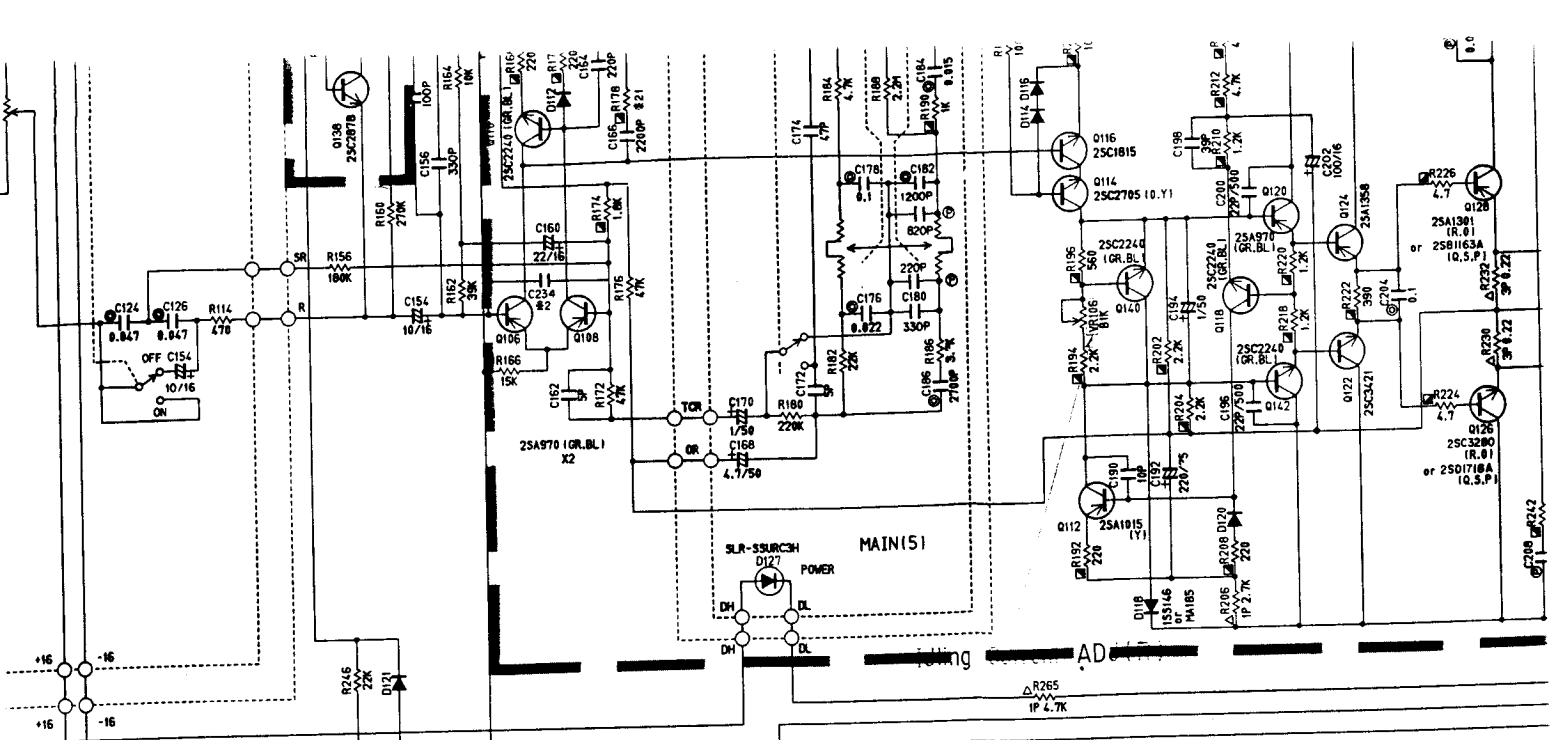

IC101: μ PC4570HA

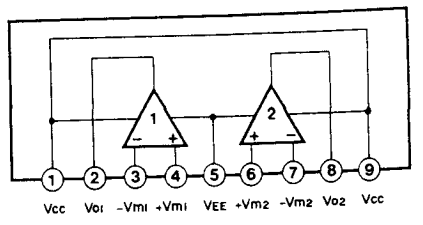

<p>HZ24-2 MTZ16C MTZ6.2B 1S5133 1S5146</p>	<p>SLR-55URC3H SLR-34URC3H4</p>	<p>4D4B41</p>	<p>μPC4570HA</p>
--	-------------------------------------	---------------	---------------------------------

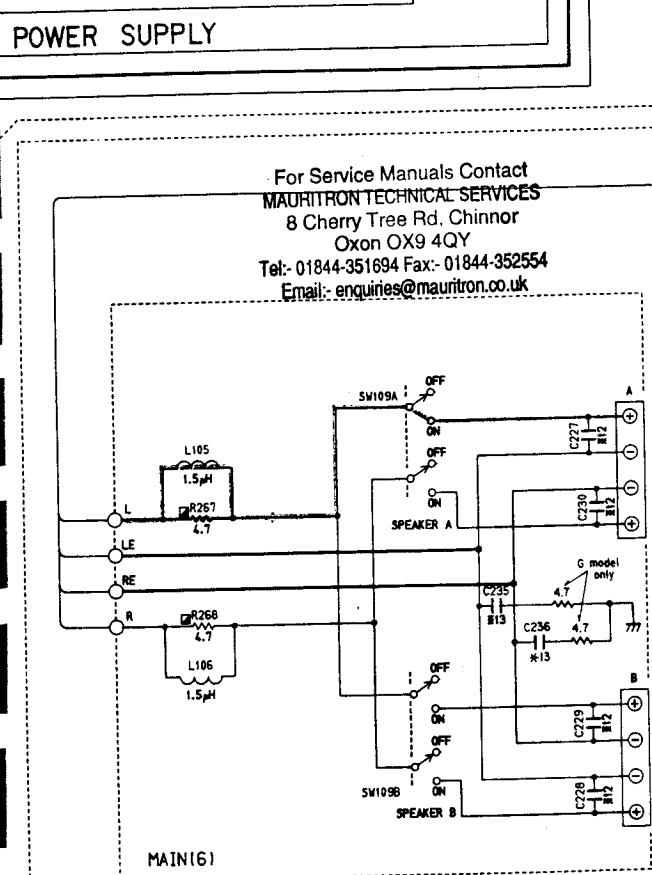
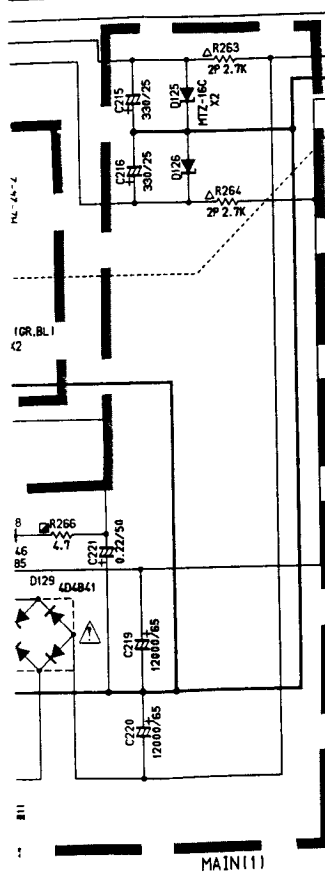
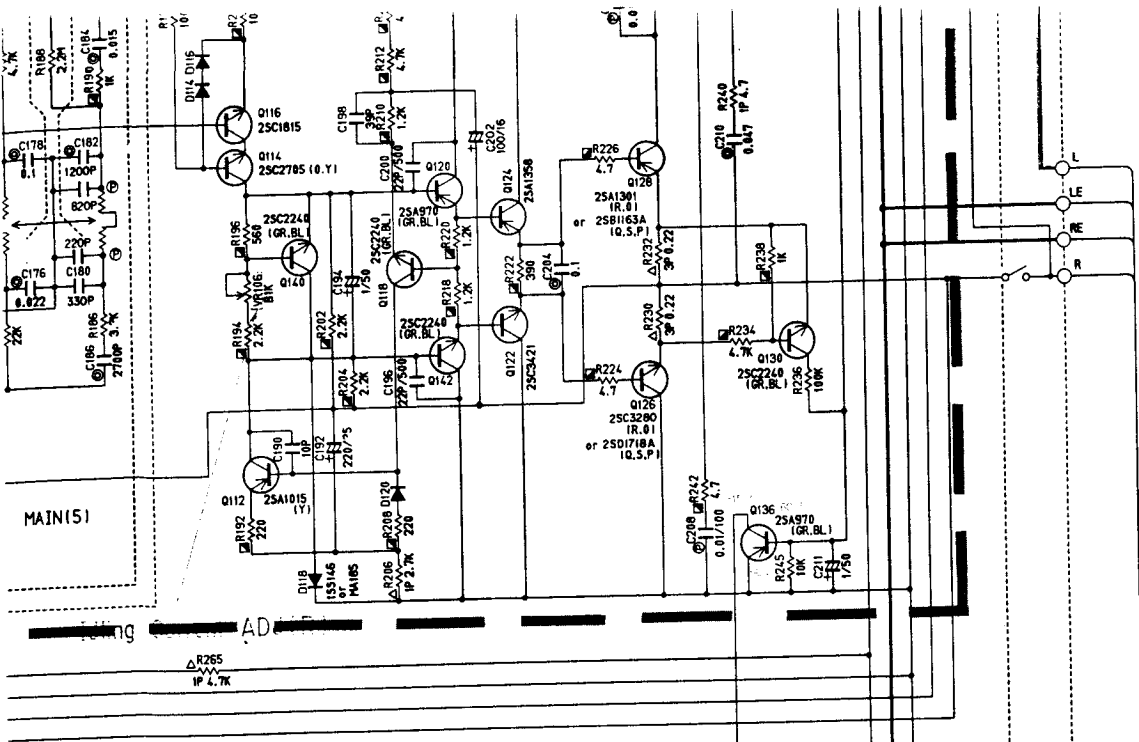

For Service Manuals Contact
MAURITRON TECHNICAL SERVICES
 8 Cherry Tree Rd. Chinnor
 Oxon OX9 4QY
 Tel:- 01844-351694 Fax:- 01844-352554
 Email:- enquiries@mauritron.co.uk

	J	U	C	R	A	B	G
*1	OPEN						5600P
*2	OPEN						270P
*3	OPEN						150P
*4	10						33
*5	100						180
*6	SHORT						15µH
*8	OPEN						220µH
*9	33						2.2K
*10	OPEN						470P
*11	OPEN						0.01
*12	OPEN						0.01
*13	OPEN						0.022
*15	220P						180P
*16	T7.0A 250V	7A125V		T7.0A 250V	T3.15A 250V		
*17	OPEN			T3.5A 250V	OPEN		
*18	OPEN						470P
*19	1500P						2700P
*20	OPEN						220P
*21	180						82

LAST NO.	UNLISTED NO.
C236	115,116,120,150,180,202,22C
R272	101,102,111,112,116,152,216,248
Q135	
D129	122

IC101: µPC4570HA

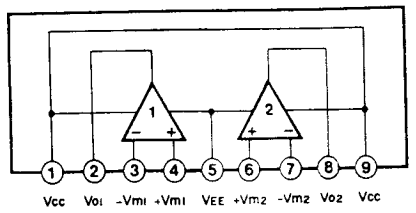

* All voltages are measured with a 10MΩ/DC electric volt meter.
 * Components having special characteristics are marked Δ and must be replaced with parts having specifications equal to those originally installed.
 * Schematic diagram is subject to change without notice.
 DM-V R Printed in Japan

PARTS LIST

AX-500/AX-500U

■WARNING

Components having special characteristics are marked Δ and must be replaced with parts having specifications equal to those originally installed.

• Carbon resistors (1/6W or 1/4W) are not included in the ELECTRICAL PARTS list. For the parts No. of the carbon resistor, refer to p. 17.

■ELECTRICAL PARTS

Ref. No.	Part No.	Description	部品名	Remarks	Common Model	Markets	ランク
*	NA 09 24 60	Main Circuit Board	メインシート			J	
*	NA 09 24 70	"	"			R	
*	NA 09 24 80	"	"			U	
*	NA 09 24 90	"	"			A,B	
*	NA 09 25 00	"	"			G	
*	NA 09 25 10	"	"			C	
	FI 32 41 00	Ceramic Cap. 0.01 μ F 250V	セラコン	C237		J	Δ
	FI 41 41 00	" 0.01 μ F	"	C223		R,U,A,C,B	Δ
	VA 98 53 00	" 0.01 μ F	"	"		G	Δ
	FG 21 05 00	" 5pF 50V	"	C161,162,171,172			
	FG 21 11 00	" 10pF 50V	"	C189,190			
	FG 21 13 90	" 39pF 50V	"	C197,198			
	FG 21 14 70	" 47pF 50V	"	C173,174			
	FG 21 23 30	" 330pF 50V	"	C155,156,179,180			
	FG 21 21 50	" 150pF 50V	"	C129,130		G	
	FG 21 21 80	" 180pF 50V	"	C137,138		G	
	FG 21 22 20	" 220pF 50V	"	"		J,R,U,A,C,B	
	FG 21 22 20	" 220pF 50V	"	C163,164			
	FG 21 22 20	" 220pF 50V	"	C231,232		G	
	FG 21 22 70	" 270pF 50V	"	C233,234		G	
	FG 21 26 80	" 680pF 50V	"	C121,122			
	FG 21 24 70	" 470pF 50V	"	C101~108,111,112		G	
	FG 21 31 50	" 1500pF 50V	"	C139,140		J,R,U,A,C,B	
	FG 21 32 70	" 2700pF 50V	"	"		G	
	FG 21 32 20	" 2200pF 50V	"	C165,166			
	FG 21 35 60	" 5600pF 50V	"	C238		G	
	FG 44 41 00	" 0.01 μ F 50V	"	C133,134			
	FG 44 41 00	" 0.01 μ F 50V	"	C122,227~230		G	
	FG 44 42 20	" 0.022 μ F 50V	"	C235,236		G	
	FU 35 12 20	Mica Cap. 22pF 500V	FEマイコン	C195,196,199,200			
	FZ 00 50 30	Semiconductive Ceramic Cap. 0.1 μ F 25V	半導体セラコン	C127			
	UA 25 31 20	Mylar Cap. 1200pF 50V	マイラーコン	C181,182			
	UA 25 24 70	" 470pF 50V	"	C109,110,113,114		G	
	UA 25 32 70	" 2700pF 50V	"	C185,186			
	UA 25 33 30	" 3300pF 50V	"	C151,152			
	UA 25 41 10	" 0.011 μ F 50V	"	C145,146			
	UA 25 41 50	" 0.015 μ F 50V	"	C183,184			
	UA 25 42 20	" 0.022 μ F 50V	"	C117,118,175,176			
	UA 25 43 90	" 0.039 μ F 50V	"	C143,144			
	UA 25 44 70	" 0.047 μ F 50V	"	C123~126,209,210			
	UA 25 51 00	" 0.1 μ F 50V	"	C177,178,203,204			
	UH 23 71 00	Electrolytic Cap. 10 μ F 16V	ケミコン	C135,136,153,154,211			
	UH 23 72 20	" 22 μ F 16V	"	C159,160,213			
	UH 23 74 70	" 47 μ F 16V	"	C212			
	UH 23 73 30	" 33 μ F 16V	"	C149			
	UH 24 82 20	" 220 μ F 25V	"	C224,225			
	UH 26 52 20	" 0.22 μ F 50V	"	C221			
	UH 26 51 00	" 0.1 μ F 50V	"	C119,120			
	UH 26 61 00	" 1 μ F 50V	"	C169,170,193,194			
	UH 26 64 70	" 4.7 μ F 50V	"	C167,168			
	UT 45 41 00	Polypropylene Film Cap. 0.01 μ F 100V	ポリプロコン	C205~208,217,218			
	UK 13 72 20	Electrolytic Cap. 22 μ F 16V	B P コン	C147,148			
	UM 04 81 00	" 100 μ F 16V	オーディオケミコン	C201,202			

*New Parts (新規部品)

For Service Manuals Contact
MAURITRON TECHNICAL SERVICES
 8 Cherry Tree Rd, Chinnor
 Oxon OX9 4QY
 Tel:- 01844-351694 Fax:- 01844-352554
 Email:- enquiries@mauritron.co.uk

Ref. No.	Part No.	Description	部 品 名	Remarks	Common Model	Markets	ランク
	UW:81:92:20	Electrolytic Cap.	2200 μ F 6.3V	ケ ミ コ ン	C141,142		
	UW:84:83:30	"	330 μ F 25V	"	C215,216		
	UW:85:82:20	"	220 μ F 35V	"	C191,192		
	UW:68:84:70	"	470 μ F 80V	"	C187		
	UW:81:82:20	"	220 μ F 6.3V	"	C214		
	UJ:11:81:00	"	100 μ F 6.3V	"	C157,158		
*	VC:40:70:00	"	12000 μ F 65V	ブ ロ ッ ク ケ ミ コ ン	C219,220		
	GD:90:04:70	Coil Output	1.5 μ H	ア ウ ト ブ ッ ト コ イ ル	L105,106		
	VA:98:35:00	Coil	15 μ H	コ イ ル	L101,102	G	
	VA:98:36:00	"	220 μ H	"	L103,104	G	
	HL:71:34:70	Metal Oxide Film Resistor	4.7 Ω 1W	酸 金 抵 抗	R239,240		
	HL:71:62:70	"	2.7k Ω 1W	"	R205,206		
	HL:71:64:70	"	4.7k Ω 1W	"	R265		
	HL:72:52:70	"	270 Ω 2W	"	R243,244		
	HL:72:62:70	"	2.7k Ω 2W	"	R263,264		
	HL:72:61:80	"	1.8k Ω 2W	"	R262		
	HL:93:22:20	"	0.22 Ω 3W	"	R229~232		
	HV:45:34:70	Flam Proof Carbon Resistor	4.7 Ω 1/4W	不 燃 化 カ ー ボ ン 抵 抗	R223~228,241,242 266~268		
	HV:45:42:20	"	22 Ω 1/4W	"	R215		
	HV:45:54:00	"	100 Ω 1/4W	"	R146,153,199,200		
	HV:45:51:80	"	180 Ω 1/4W	"	R177,178	J,R,U,A,C,B	
	HV:45:48:20	"	82 Ω 1/4W	"	"	G	
	HV:45:52:20	"	220 Ω 1/4W	"	R167~170,191, 192,207,208		
	HV:45:53:90	"	390 Ω 1/4W	"	R221,222		
	HV:45:55:60	"	560 Ω 1/4W	"	R195,196		
	HV:45:61:00	"	1k Ω 1/4W	"	R189,190,237,238		
	HV:45:61:20	"	1.2k Ω 1/4W	"	R209,210,217~ 220		
	HV:45:61:80	"	1.8k Ω 1/4W	"	R173,174		
	HV:45:62:20	"	2.2k Ω 1/4W	"	R193,194, 201~204		
	HV:45:64:70	"	4.7k Ω 1/4W	"	R211~214,223, 234		
	VA:78:76:00	Pre-Set Potentiometer	B1k Ω	半 固 定 抵 抗	VR106,107		
*	VC:23:71:00	Potentiometer	250KMN	可 変 抵 抗 器	VR102		
	VC:23:72:00	"	80K特	"	VR105		
	VC:23:73:00	"	100K特	"	VR104		
	VC:23:74:00	"	60KY	"	VR103		
	VC:29:74:00	"	300K特	"	VR101		
	iA:09:70:00	Transistor	2SA970(GR,BL)	ト ラ ン ジ ス タ	Q101~108,119, 120,131,136		
	iA:10:15:21	"	2SA1015(Y)	"	Q111,112		
	iC:18:15:20	"	2SC1815(Y)	"	Q115,116,132, 133		
	iC:22:40:00	"	2SC2240(GR,BL)	"	Q109,110,117,118,129 130,134,135,141,142		
	iX:60:08:90	"	2SC2878	"	Q137,138		
	iC:22:40:00	"	2SC2240(GR,BL)	"	Q139,140		
	iC:27:05:00	"	2SC2705(O,Y)	"	Q113,114		
	iX:60:85:10	"	2SA1358	"	Q123,124		
	iX:60:85:20	"	2SC3421	"	Q121,122		
	iF:00:19:40	Zener Diode	HZ24-2	ツ ェ ナ ー ダイ オ ード	D124		
	iF:00:86:40	"	MTZ16C	"	D125,126		
	iF:00:10:70	"	MTZ6.2B	"	D103		

*New Parts (新規部品)

Ref. No.	Part No.	Description	部 品 名	Remarks	Common Model	Markets	ランク
	iF 00:42:70	LED	SLR-55URC3H	L E D	D127		
	iF 00:23:80	"	SLR-34URC3H4	"	D104~110		
	iF 00:46:00	Diode	1SS133	ダイ オ ード	D101,102,111~116, 119~121,123		
	iF 00:61:30	"	1SS146	"	D117,118,128		
	iH 00:08:70	Diode Bridge	4D4B41	ダイオードブリッジ	D129		
	XB 24:70:01	IC	PC4570HA	I C	IC101		
	KC 00:19:40	Relay	DH24D2-OTM	リ レ ー	RY101		
	KC 00:20:00	"	JR2A-DC24V	"	"	Interchangeable	
	VC 17:67:00	Push Switch	NS4-2	プッシュスイッチ	SW105		
*	VC 24:55:00	"	NS2-2	"	SW104,106		
*	VC 23:77:00	"	6連連動NS4-2	"	SW103		
*	VC 36:99:00	"	6-2	"	SW101		
*	VC 37:24:00	"	2連連動SPUF2-2	"	SW109		
*	VC 37:81:00	"	S2-2	"	SW108		
*	VC 23:78:00	Rotary Switch	SRZ-U	ロータリースイッチ	SW102		
*	VC 40:97:00	Power Switch	TV-4	パワースイッチ	SW107		△
	KB 00:03:70	Fuse	T3.5A 250V	ヒ ュ ー ズ	F102	R	△
	KB 00:07:60	"	T3.15A 250V	"	F101	A,G,B	△
	KB 00:13:00	"	T7.0A 250V	"	"	J,R	△
	KB 00:15:20	"	7A 125V	"	"	U,C	△
	LB 30:16:90	Phone Jack		ヘッドホーンジャック	JK101		
	LB 20:22:90	Pin Jack	2P	ピンジャック	PJ105		
	LB 40:10:30	"	4P	"	PJ101,102,104		
	LB 60:60:90	"	6P	"	PJ103		
	VA 93:29:00	Voltage Selector		電 圧 切 換 器			△
	CB 64:46:70	Cover Capacitor	HY-0105	コンデンサーカバー		G	
	LB 20:10:60	Fuse Holder Pin	YSH403T	ヒューズホルダーピン		A,G,B	
	LB 20:19:70	"	23165081	"		J,R,U,C	
	LB 60:42:80	AC Outlet		A C アウトレット		J,R	△
	LB 60:81:70	"		"		U,C	△
	VA 72:55:00	Holder, Wire	5P	パラレルホルダー			
	VA 72:58:00	"	8P	"			
	VA 72:60:00	"	10P	"			
	VA 72:62:00	"	12P	"			
	VB 22:98:00	Wire Trap	8P	ワイヤートラップ			
	VA 72:53:00	Holder, Wire	3P	パラレルホルダー			
*	VC 31:37:00	Speaker Terminal	8P	スピーカーターミナル		J,R,U,A,C,B	
*	VC 72:09:00	"	8P	"		G	
	VA 82:15:00	Heat Sink		放 熱 板		C	
	BB 06:95:10	Ground Plate		ラ ン ド 金 具			
*	BB 07:13:60	Terminal, Screw		ネ ジ 端 子			
	EK 33:00:20	Cup Screw	3x14 FCRM3-BI	カップスクリュー(Bタイプ)		C	
					For Service Manuals Contact MAURITRON TECHNICAL SERVICES 8 Cherry Tree Rd, Chinnor Oxon OX9 4QY Tel: 01844-351694 Fax: 01844-352554 Email: enquires@maurtron.co.uk		

*New Parts (新規部品)

EXPLODED VIEW

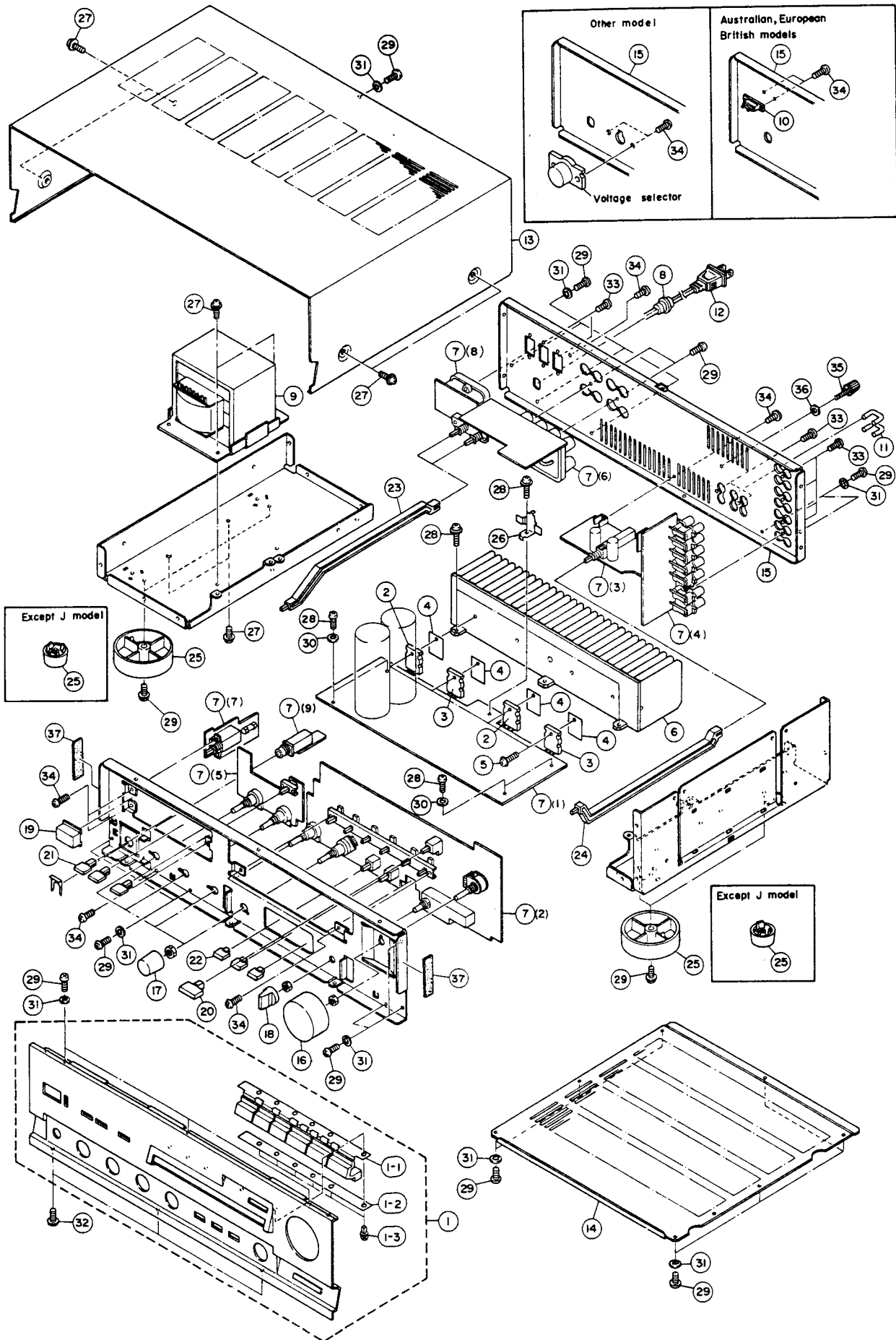

MECHANISM PARTS

Note) ϕ : Diameter

Ref. No.	Part No.	Description	部 品 名	Remarks	Common Model	Markets	ランク
* 1	NB 64 00 30	Panel Unit	パネルユニット	Silver		R,A,G,B	
* "	NB 64 00 50	"	"	Black		R,A,G,B	
* "	NB 64 00 40	"	"	Silver		U,C	
* "	NB 64 00 60	"	"	Black		U,C	
* "	NB 64 09 40	"	"	Black		J	
* "	NB 64 09 50	"	"	Silver		J	
* 1-1	CB 65 91 90	Button, Input	ボタンインプット	Black			
* "	CB 65 92 00	"	"	Silver			
1-2	AA 63 22 00	Spacer	スペーサ				
1-3	CB 09 96 00	Plastic Rivet	プラスチックリベット				
2	iX 60 81 10	Transistor	2SA1301(R,O) トランジスタ	Q127, 128	Inter-changeable		
"	iX 60 81 30	"	2SB1163A(Q,S,P) "	"			
3	iX 60 81 20	"	2SC3280(R,O) "	Q125, 126	Inter-changeable		
"	iX 60 81 40	"	2SD1718A(Q,S,P) "	"			
* 4	VC 65 78 00	Sheet	シン.エツシート				
* "	VC 39 72 00	"	デンカシート				
5	EK 33 00 20	BW Head Tapping Screw	3x14(ϕ 10)ZMC2-BI BWヘッドタッピングネジ				
* 6	BA 09 55 60	Heat Sink	放熱シート			J	
* 7	NA 09 24 60	Main Circuit Board	メインシート			R	
* "	NA 09 24 70	"	"			U	
* "	NA 09 24 80	"	"			A,B	
* "	NA 09 24 90	"	"			G	
* "	NA 09 25 00	"	"			C	
* "	NA 09 25 10	"	"			J	
8	CB 61 68 10	Cord Stopper	CM-22A コードストッパー			R,A,G,B	
"	CB 62 01 90	"	CM-22A "			U,C	
"	CB 62 02 00	"	CM-22C "			R	
* 9	XB 79 10 02	Power Transformer	電源トランス			J	△
* "	XB 79 00 02	"	"			U	△
* "	XB 79 20 02	"	"			A,B	△
* "	XB 79 30 02	"	"			G	△
* "	XB 79 40 02	"	"			C	△
* "	XB 79 50 02	"	"			A,G,B	△
10	LA 00 29 50	Terminal Board	2P 中継端子台				
11	LB 10 11 10	Plug, Short	ショートプラグ				
12	MG 00 17 50	Power Cord	7A 125V2.2m 電源コード	Inter-changeable		J	△
"	MG 00 17 60	"	7A 125V2.2m "			J	△
"	MG 00 16 30	"	6A 250V 2m "			R	△
"	MG 00 22 20	"	10A 125V 1.98m "	Inter-changeable		U,C	△
"	MG 00 23 70	"	10A 125V 2m "			U,C	△
"	MG 00 09 20	"	7.5A 250V 2.5m "	Inter-changeable		A	△
"	MG 00 14 90	"	7.5A 250V 2.5m "			A	△
"	MG 00 23 10	"	7.5A 250V 2m "			A	△
"	MG 00 16 20	"	2.5A 250V 2m "			G	△
"	MG 00 18 60	"	2.5A 250V 2m "			B	△
* 13	AA 63 12 80	Top Cover	トップカバー	Black			
* "	AA 63 12 90	"	"	Silver			
* 14	AA 63 13 20	Bottom Cover	ボトムカバー			J	
* 15	AA 63 13 30	Rear Panel	リアパネル			R	
* "	AA 63 13 40	"	"			U,C	
* "	AA 63 13 50	"	"			G	
* "	AA 63 13 60	"	"			A,B	
* "	AA 63 13 70	"	"				

*New Parts (新規部品)

For Service Manuals Contact
MAURITRON TECHNICAL SERVICES
8 Cherry Tree Rd, Chinnor
Oxon OX9 4QY
Tel: 01844-351694 Fax: 01844-352554
Email: enquiries@mauritron.co.uk

Parts List for Carbon Resistor

Value	1/4W Type Part No.	1/6W Type Part No.	Value	1/4W Type Part No.	1/6W Type Part No.
1.0 Ω	HJ353100	*	12K Ω	HJ357120	HF857120
1.8 "	HJ353180	*	15 "	HJ357150	HF857150
2.2 "	HJ353220	HF853220	18 "	HJ357180	HF857180
3.3 "	HJ353330	HF853330	22 "	HJ357220	HF857220
4.7 "	HJ353470	HF853470	27 "	HJ357270	HF857270
5.6 "	HJ353560	HF853560	33 "	HJ357330	HF857330
10 "	HJ354100	HF854100	39 "	HJ357390	HF857390
15 "	HJ354150	HF854150	47 "	HJ357470	HF857470
22 "	HJ354220	HF854220	56 "	HJ357560	HF857560
27 "	HJ354270	HF854270	68 "	HJ357680	HF857680
33 "	HJ354330	HF854330	82 "	HJ357820	HF857820
39 "	HJ354390	HF854390	91 "	HJ357910	HF857910
47 "	HJ354470	HF854470	100 "	HJ358100	HF858100
56 "	HJ354560	HF854560	120 "	HJ358120	HF858120
68 "	HJ354680	HF854680	150 "	HJ358150	HF858150
82 "	HJ354820	HF854820	180 "	HJ358180	HF858180
100 "	HJ355100	HF855100	220 "	HJ358220	HF858220
110 "	HJ355110	HF855110	270 "	HJ358270	HF858270
120 "	HJ355120	HF855120	330 "	HJ358330	HF858330
150 "	HJ355150	HF855150	390 "	HJ358390	HF858390
160 "	HJ355160	*	470 "	HJ358470	HF858470
180 "	HJ355180	HF855180	560 "	HJ358560	HF858560
220 "	HJ355220	HF855220	680 "	HJ358680	HF858680
270 "	HJ355270	HF855270	820 "	HJ358820	HF858820
330 "	HJ355330	HF855330	1.0M Ω	HJ359100	HF859100
390 "	HJ355390	HF855390	1.2 "	HJ359120	*
470 "	HJ355470	HF855470	1.5 "	HJ359150	HF859150
510 "	*	HF855510	1.8 "	HJ359180	HF859180
560 "	HJ355560	HF855560	2.2 "	HJ359220	HF859220
680 "	HJ355680	HF855680	3.3 "	HJ359330	HF859330
820 "	HJ355820	HF855820	3.9 "	HJ359390	*
910 "	HJ355910	HF855910	4.7 "	HJ359470	*
1.0K Ω	HJ356100	HF856100			
1.2 "	HJ356120	HF856120			
1.5 "	HJ356150	HF856150			
1.8 "	HJ356180	HF856180			
2.0 "	HJ356200	HF856200			
2.2 "	HJ356220	HF856220			
2.4 "	HJ356240	HF856240			
2.7 "	HJ356270	HF856270			
3.0 "	HJ356300	HF856300			
3.3 "	HJ356330	HF856330			
3.6 "	HJ356360	HF856360			
3.9 "	HJ356390	HF856390			
4.7 "	HJ356470	HF856470			
5.1 "	HJ356510	HF856510			
5.6 "	HJ356560	HF856560			
6.8 "	HJ356680	HF856680			
8.2 "	HJ356820	HF856820			
9.1 "	HJ356910	HF856910			
10 "	HJ357100	HF857100			

